

DECouvrez LE PLANAR ECO

Généralités

PLANAR ECO

Le radiateur Planar ECO avec alimentation en série (le panneau avant est alimenté en premier) est bien adapté aux systèmes basse température. La technologie ECO garantit un haut rendement énergétique, un rayonnement maximal, une chauffe rapide et des déperditions de chaleur réduites du côté du mur.

En combinant cette technologie avec une face plane et un habillage complet, vous pouvez profiter du luxe de notre chaleur verte.

Produit:	le radiateur décoratif basse température avec alimentation en série, raccordement central et latéral inférieur; vanne pré-réglée montable à gauche ou à droite et à face plane
Finition:	face plane décorative plane avec grille supérieure et joues
Prémonté:	vanne Heimeier pré-réglée 4368 ou 4369, purgeur ECO et bouchons pleins
Vanne:	la vanne réglable intégrée (sans tête thermostatique), certifiée CEN et testée selon EN215, est compatible aux têtes thermostatiques M30 x 1,5 mm. Elle est montée d'usine à droite mais peut être montée à gauche (types 21-33), sans devoir adapter les conduites d'alimentation et de retour, ni retourner le radiateur. La vanne est pré-réglée en usine en fonction des dimensions du radiateur, ce qui permet d'obtenir un rendement optimal. Ce pré-réglage garantit par ailleurs un débit optimal dans le radiateur. Réglage en usine adapté à des installations bitube, convenant aussi pour des installations monotube (moyennant l'adaptation du réglage de la vanne sur la position 8).
Fourni avec:	consoles VDI avec anti-soulèvement (type Monclac), vis, chevilles et instructions de montage
Raccordements:	2 raccords Eurocône ¾" à filetage extérieur au centre et 2 raccords ½" à filetage intérieur
Étriers:	2 paires d'étriers jusqu'à 1.600 mm et 3 paires à partir de 1.800 mm
Emballage:	Chaque radiateur est solidement emballé dans un carton de qualité et plastifié. Une étiquette décrit les caractéristiques du radiateur: type – hauteur – longueur.
Garantie:	10 ans sous réserve de respecter les prescriptions concernant les conditions d'installation ainsi que les conditions de garantie de Stelrad.
Procédé de laquage:	Tous les radiateurs sont dégraissés, phosphatés, enduits d'une couche de protection primaire par cataphorèse et d'un poudrage électrostatique dans la couleur blanc Stelrad 9016.
Couleurs:	blanc Stelrad 9016 + 35 autres couleurs de Stelrad ou 200 couleurs RAL
Pression de service max.:	10 bar (testé à 13 bar)
Température max.:	110 °C
Conformité:	selon EN442
Types:	11 21 22 33
Hauteurs:	300 400 500 600 700 900 mm
Longueurs:	400 – 3.000 mm
Profondeurs:	63 79 102 160 mm



Données techniques

Caractéristiques nominales et émissions suivant EN442 75/65/20°C et par mètre de radiateur

Formule caractéristique

$$\Phi = K_M \times \Delta T^n$$

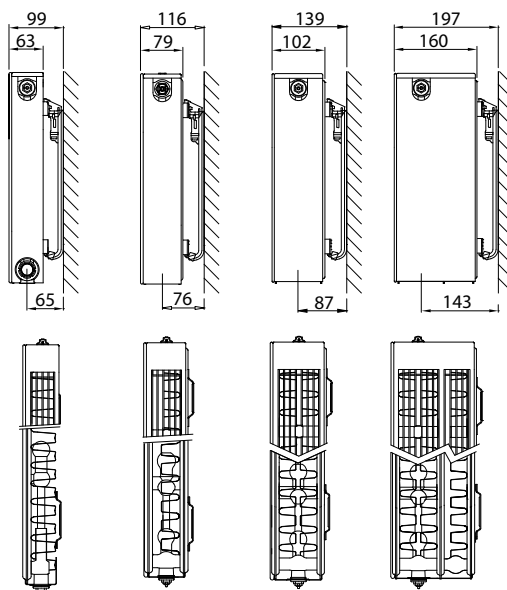

Hauteur		Type 11	Type 21	Type 22	Type 33	Hauteur
300	W	469	705	887	1.259	300
	kg	11,88	16,63	18,85	26,45	
	l	1,89	3,29	2,90	4,35	
	m ²	2,09	2,44	3,51	5,26	
	n	1,30	1,26	1,27	1,31	
400	W	626	886	1.117	1.587	400
	kg	16,13	21,95	24,95	35,12	
	l	2,34	4,11	3,88	5,82	
	m ²	2,95	3,37	4,92	7,38	
	n	1,29	1,28	1,28	1,32	
500	W	774	1.053	1.333	1.893	500
	kg	20,39	27,28	31,05	43,78	
	l	2,80	4,93	4,87	7,28	
	m ²	3,80	4,31	6,33	9,49	
	n	1,28	1,30	1,29	1,35	
600	W	911	1.208	1.537	2.180	600
	kg	24,65	32,60	37,15	52,45	
	l	3,25	5,75	5,85	8,75	
	m ²	4,66	5,24	7,74	11,61	
	n	1,27	1,30	1,29	1,35	
700	W	1.038	1.353	1.732	2.452	700
	kg	28,91	37,85	42,82	61,13	
	l	3,77	6,63	6,73	10,19	
	m ²	5,51	6,18	9,15	13,72	
	n	1,28	1,29	1,30	1,34	
900	W	1.260	1.616	2.096	2.952	900
	kg	37,43	48,35	54,15	78,50	
	l	4,80	8,40	8,50	13,06	
	m ²	7,22	8,05	11,97	17,96	
	n	1,29	1,29	1,31	1,34	

W=puissance par mètre / kg=poids par mètre / l=contenance par mètre / m²=surface par mètre / n=pente
Le fabricant se réserve le droit de changer les spécifications sans avis préalable.

PLANAR ECO

Émissions calorifiques suivant EN442



EN442 (W) 70/50/20°C

EN442 (W) 55/45/20°C

Stelrad B.V./PLI 18(0149)/E008

Hauteur	300			
	11	21	22	33
Type	11	21	22	33
W/m 75/65/20°C	469	705	887	1.259
400	141 97 0541031104	213 148 0541032104	267 185 0541032204	376 258 0541033304
500	175 120 0541031105	265 185 0541032105	334 232 0541032205	470 322 0541033305
600	210 145 0541031106	319 222 0541032106	400 278 0541032206	563 386 0541033306
700	245 169 0541031107	373 259 0541032107	467 324 0541032207	657 451 0541033307
800	280 193 0541031108	425 296 0541032108	534 370 0541032208	751 515 0541033308
900	316 217 0541031109	478 332 0541032109	601 416 0541032209	845 580 0541033309
1000	351 241 0541031110	532 370 0541032110	668 463 0541032210	940 644 0541033310
1100	386 265 0541031111	585 407 0541032111	735 509 0541032211	1.034 709 0541033311
1200	421 290 0541031112	638 443 0541032112	801 555 0541032212	1.128 773 0541033312
1400	491 338 0541031114	744 517 0541032114	935 648 0541032214	1.316 902 0541033314
1600		851 591 0541032116	1.068 740 0541032216	1.503 1.030 0541033316
1800		957 665 0541032118	1.202 833 0541032218	1.691 1.159 0541033318
2000		1.063 739 0541032120	1.335 926 0541032220	1.879 1.288 0541033320
2200		1.170 813 0541032122	1.468 1.018 0541032222	2.067 1.417 0541033322
2400		1.276 887 0541032124	1.602 1.111 0541032224	2.255 1.546 0541033324
2600			1.736 1.203 0541032226	
2800			1.870 1.296 0541032228	
3000			2.003 1.388 0541032230	

400			
11	21	22	33
626	886	1.117	1.587
187 129 0541041104	266 185 0541042104	336 232 0541042204	473 323 0541043304
235 162 0541041105	333 231 0541042105	419 290 0541042205	591 404 0541043305
282 194 0541041106	400 277 0541042106	504 348 0541042206	709 484 0541043306
328 226 0541041107	466 323 0541042107	588 407 0541042207	827 565 0541043307
376 259 0541041108	533 370 0541042108	672 465 0541042208	945 646 0541043308
422 291 0541041109	600 415 0541042109	755 523 0541042209	1.063 726 0541043309
469 324 0541041110	667 462 0541042110	839 581 0541042210	1.181 807 0541043310
516 356 0541041111	733 508 0541042111	924 639 0541042211	1.300 888 0541043311
563 388 0541041112	800 554 0541042112	1.007 697 0541042212	1.417 969 0541043312
657 453 0541041114	933 646 0541042114	1.175 813 0541042214	1.654 1.130 0541043314
751 518 0541041116	1.067 739 0541042116	1.343 929 0541042216	1.890 1.292 0541043316
845 583 0541041118	1.200 831 0541042118	1.511 1.046 0541042218	2.127 1.453 0541043318
939 647 0541041120	1.333 924 0541042120	1.679 1.162 0541042220	2.363 1.615 0541043320
	1.466 1.016 0541042122	1.846 1.278 0541042222	2.599 1.776 0541043322
	1.599 1.108 0541042124	2.015 1.394 0541042224	2.835 1.938 0541043324
		2.182 1.510 0541042226	
		2.351 1.627 0541042228	
		2.518 1.742 0541042230	

500			
11	21	22	33
774	1.053	1.333	1.893
233 161 0541051104	315 217 0541052104	400 276 0541052204	560 380 0541053304
291 201 0541051105	393 271 0541052105	500 345 0541052205	700 475 0541053305
349 241 0541051106	473 325 0541052106	600 414 0541052206	841 571 0541053306
407 282 0541051107	551 379 0541052107	700 483 0541052207	981 666 0541053307
465 322 0541051108	630 433 0541052108	800 552 0541052208	1.121 761 0541053308
524 362 0541051109	709 488 0541052109	900 622 0541052209	1.261 856 0541053309
582 402 0541051110	788 542 0541052110	1.000 691 0541052210	1.401 951 0541053310
639 442 0541051111	866 596 0541052111	1.100 759 0541052211	1.541 1.046 0541053311
698 483 0541051112	946 650 0541052112	1.200 829 0541052212	1.682 1.141 0541053312
814 563 0541051114	1.103 758 0541052114	1.400 967 0541052214	1.962 1.331 0541053314
930 643 0541051116	1.260 867 0541052116	1.600 1.105 0541052216	2.242 1.522 0541053316
1.047 724 0541051118	1.418 975 0541052118	1.800 1.243 0541052218	2.522 1.711 0541053318
1.163 804 0541051120	1.575 1.084 0541052120	2.000 1.381 0541052220	2.803 1.902 0541053320
1.279 885 0541051122	1.733 1.192 0541052122	2.201 1.520 0541052222	3.083 2.092 0541053322
1.396 965 0541051124	1.890 1.300 0541052124	2.400 1.657 0541052224	3.363 2.282 0541053324
		2.601 1.796 0541052226	
		2.800 1.933 0541052228	
		3.000 2.072 0541052230	

La gamme de base (blanc Stelrad 9016) est disponible départ usine sous 10 jours ouvrés.

La gamme de base est sujette à changement sans préavis. Veuillez consulter le site www.stelrad.eu pour les données à jour.

Les délais de livraison des autres produits dépendent du modèle: consultez votre grossiste.

PLANAR ECO

Art. 0541 09 22 04

Etiquette:
PLAN ECO T11-33: 0541
PLAN ECO L (Gauche) T11-33: 0442

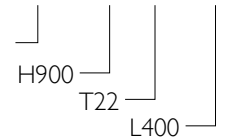

Hauteur	600			
	11	21	22	33
Type	11	21	22	33
W/m 75/65/20°C	911	1.208	1.537	2.180
400	274 190 0541061104	362 249 0541062104	461 318 0541062204	646 439 0541063304
500	343 238 0541061105	452 311 0541062105	575 397 0541062205	807 548 0541063305
600	412 286 0541061106	543 374 0541062106	691 476 0541062206	969 658 0541063306
700	480 333 0541061107	633 436 0541062107	806 556 0541062207	1.130 767 0541063307
800	549 381 0541061108	723 498 0541062108	922 635 0541062208	1.292 877 0541063308
900	617 428 0541061109	814 560 0541062109	1.036 714 0541062209	1.453 987 0541063309
1000	686 476 0541061110	904 623 0541062110	1.152 794 0541062210	1.615 1.096 0541063310
1100	754 523 0541061111	995 685 0541062111	1.267 873 0541062211	1.776 1.206 0541063311
1200	823 571 0541061112	1.085 747 0541062112	1.382 952 0541062212	1.937 1.316 0541063312
1400	960 666 0541061114	1.266 871 0541062114	1.612 1.111 0541062214	2.260 1.535 0541063314
1600	1.098 761 0541061116	1.447 996 0541062116	1.842 1.270 0541062216	2.583 1.754 0541063316
1800	1.235 857 0541061118	1.627 1.120 0541062118	2.073 1.429 0541062218	2.906 1.973 0541063318
2000	1.372 952 0541061120	1.809 1.245 0541062120	2.303 1.588 0541062220	3.229 2.193 0541063320
2200	1.509 1.047 0541061122	1.990 1.370 0541062122	2.533 1.746 0541062222	3.552 2.412 0541063322
2400	1.646 1.142 0541061124	2.170 1.494 0541062124	2.764 1.905 0541062224	3.875 2.631 0541063324
2600			2.994 2.064 0541062226	
2800			3.225 2.223 0541062228	
3000			3.455 2.381 0541062230	

700			
11	21	22	33
1.038	1.353	1.732	2.452
312 216 0541071104	405 279 0541072104	519 357 0541072204	727 494 0541073304
390 270 0541071105	506 349 0541072105	648 446 0541072205	908 617 0541073305
468 324 0541071106	608 419 0541072106	777 535 0541072206	1.090 741 0541073306
547 378 0541071107	709 489 0541072107	907 624 0541072207	1.272 864 0541073307
624 432 0541071108	811 559 0541072108	1.037 714 0541072208	1.454 988 0541073308
702 486 0541071109	912 629 0541072109	1.167 803 0541072209	1.635 1.111 0541073309
780 540 0541071110	1.014 698 0541072110	1.296 892 0541072210	1.817 1.234 0541073310
859 594 0541071111	1.115 768 0541072111	1.425 981 0541072211	1.998 1.358 0541073311
937 649 0541071112	1.217 838 0541072112	1.555 1.070 0541072212	2.180 1.481 0541073312
1.092 756 0541071114	1.419 978 0541072114	1.815 1.249 0541072214	2.544 1.728 0541073314
1.249 865 0541071116	1.622 1.118 0541072116	2.073 1.427 0541072216	2.907 1.975 0541073316
1.404 972 0541071118	1.824 1.257 0541072118	2.333 1.605 0541072218	3.271 2.222 0541073318
1.561 1.081 0541071120	2.027 1.397 0541072120	2.592 1.783 0541072220	3.634 2.469 0541073320

900			
11	21	22	33
1.260	1.616	2.096	2.952
378 261 0541091104	485 335 0541092104	625 429 0541092204	876 596 0541093304
472 326 0541091105	606 418 0541092105	782 536 0541092205	1.095 745 0541093305
567 391 0541091106	728 502 0541092106	939 644 0541092206	1.314 894 0541093306
661 456 0541091107	849 586 0541092107	1.095 751 0541092207	1.532 1.042 0541093307
756 521 0541091108	970 670 0541092108	1.251 858 0541092208	1.752 1.192 0541093308
850 586 0541091109	1.091 753 0541092109	1.407 965 0541092209	1.971 1.341 0541093309
945 651 0541091110	1.212 837 0541092110	1.564 1.072 0541092210	2.189 1.489 0541093310
1.039 717 0541091111	1.334 921 0541092111	1.721 1.180 0541092211	2.408 1.638 0541093311
1.133 782 0541091112	1.455 1.004 0541092112	1.877 1.287 0541092212	2.627 1.787 0541093312
1.322 912 0541091114	1.697 1.172 0541092114	2.189 1.501 0541092214	3.065 2.085 0541093314
1.511 1.042 0541091116	1.940 1.339 0541092116	2.503 1.716 0541092216	3.503 2.383 0541093316
1.700 1.173 0541091118	2.182 1.507 0541092118	2.816 1.930 0541092218	3.941 2.681 0541093318
1.889 1.303 0541091120	2.425 1.674 0541092120	3.128 2.145 0541092220	4.379 2.979 0541093320

MODES DE RACCORDEMENT

Types 21/22/33

Radiateur
face avant
en version gauche

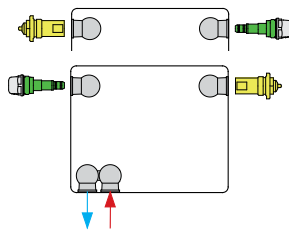

Types 21/22/33

Radiateur
face avant
en version droite

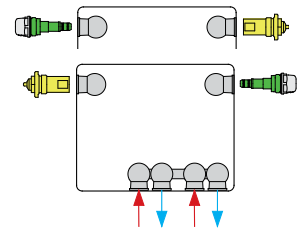

Type II

Radiateur
face avant
en version gauche

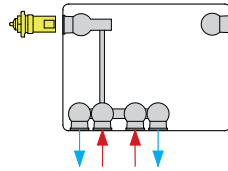

Type II

Radiateur
face avant
en version droite

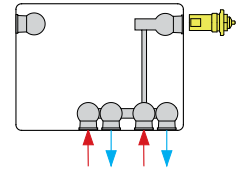

DIMENSIONS DE RACCORDEMENT

Types 21/22/33

Gauche

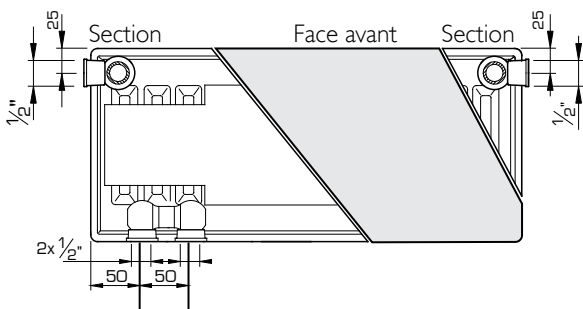

Types 21/22/33

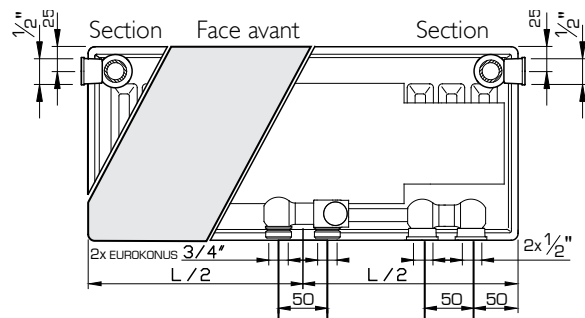

Type II

Gauche

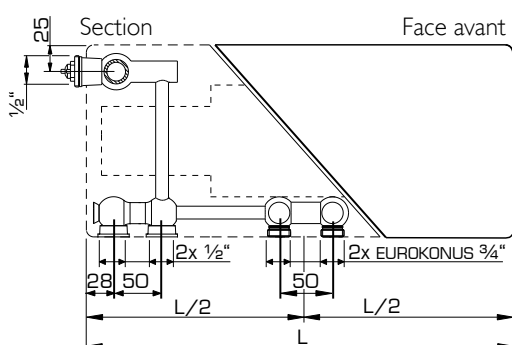

Type II

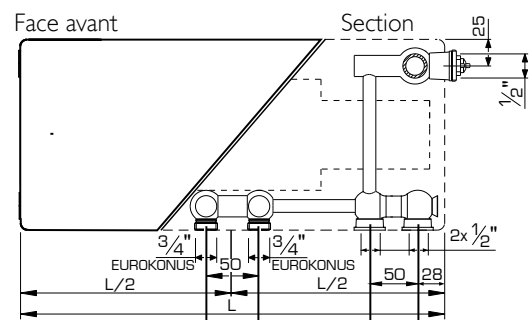

CONSOLES J (TYPE MONCLAC VDI 6036)

Type 11 Type 21 Type 22 Type 33

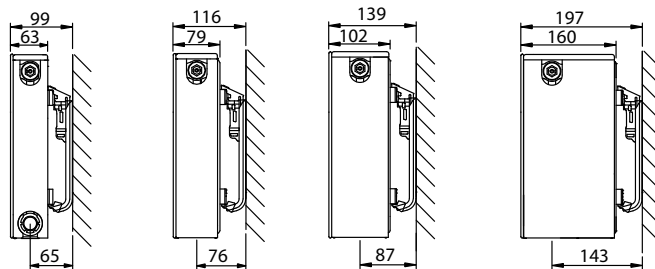

Types 11-33 Consoles J VDI 6036 Cl. 3		x	y	N° d'art.		Hauteur mm
				2 pc.	3 pc.	
<p>Bord inférieur radiateur</p>	/	140	R509203	R509303	300	
	103	240	R509204	R509304	400	
	103	340	R509205	R509305	500	
	103	440	R509206	R509306	600	
	103	540	R509207	R509307	700	
	103	740	R509209	R509309	900	

À partir de L 1800 mm: 3 consoles.

POSITIONS DES ÉTRIERS

Types 21/22/33

L	A
400-1600	133

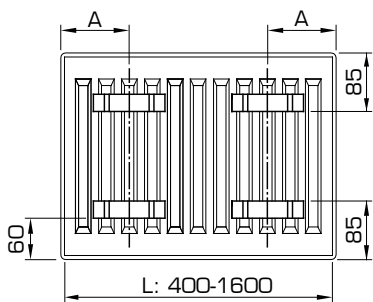

Types 21/22/33

L	A
1800-3000	133

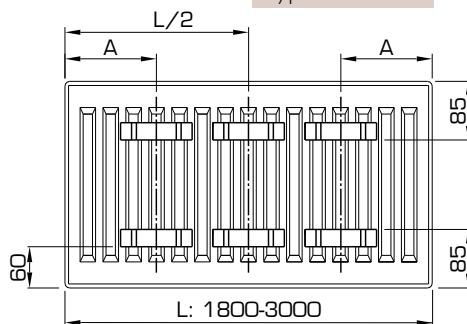

Type 11

L	A
400	117
500-1600	150

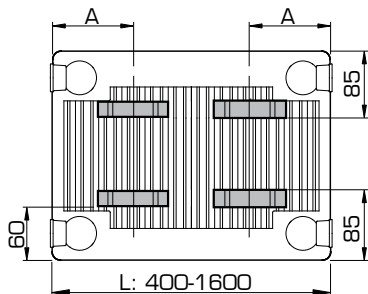

Type 11

L	A
1800-3000	150

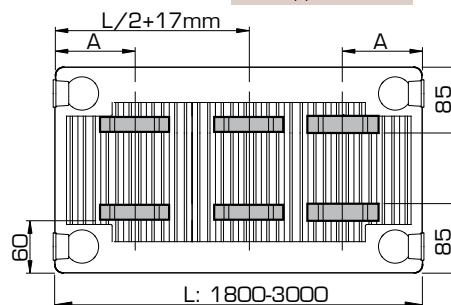



Seasons

change,

and so

do we !

Allemagne • Autriche • Belgique • Biélorussie • Chypre • Espagne • Estonie • France • Grèce • Irlande • Islande • Lituanie
Luxembourg • Pays-Bas • Portugal • Norvège • Pologne • Royaume-Uni • Slovénie • Suède • République Tchèque • Tunisie • Ukraine

PAYS-BAS

Caradon Stelrad B.V. | Kathagen 30 | 6361 HG Nuth

WWW.STELRAD.EU



Stelrad
Europe's favourite radiator