



DISCOVER VERTEX

General information

VERTEX

Do you only have limited space to fit a radiator? The Vertex is the solution. This vertical radiator takes up a minimum of space and optimally heats the cold air next to large window section.

Product:	vertical panel radiator with a centre connection
Finishing:	side panels (only for types 11, 20, 21 and 22)
Also supplied:	wall brackets, ETA safety screws and plugs, screws, plugs, air vent, blind plugs and installation instructions
Connections:	4 x ½" female connection (centre connection included). Types 20, 21 and 22 can be reversed (front/back), in which case inlet and outlet are also reversed.
Lugs:	no lugs
Packaging:	Every radiator is sturdily packaged in high-quality cardboard and wrapped in plastic. The radiator's characteristics are shown on the label: type – height – length.
Warranty:	10 years, as long as the installation instructions have been followed and Stelrad's warranty conditions have been met.
Paint process:	All radiators are degreased, phosphated, cathodically primed and powder-coated in Stelrad white 9016 as standard.
Colours:	Stelrad white 9016 + 35 different Stelrad colours and about 200 RAL-colours are possible
Heat cost allocator:	Suitable for heat cost allocators, both electronic and according to the evaporation principle (covered by the norm of EN834 & EN835).
Max. operating pressure:	10 bar (tested to 13 bar)
Max. operating temperature:	110 °C
Conformity:	in accordance with EN442
Quality assurance:	NF
Types:	10 11 20 21 22
Heights:	1.600 1.800 2.000 2.200 mm
Lengths:	300 400 500 600 700 mm
Depths:	47 47 77 77 100 mm



Type overview

Calculation factor per meter at 75/65/20°C according to EN442

Characteristic equation:

$$\Phi = K_M \times \Delta T^n$$

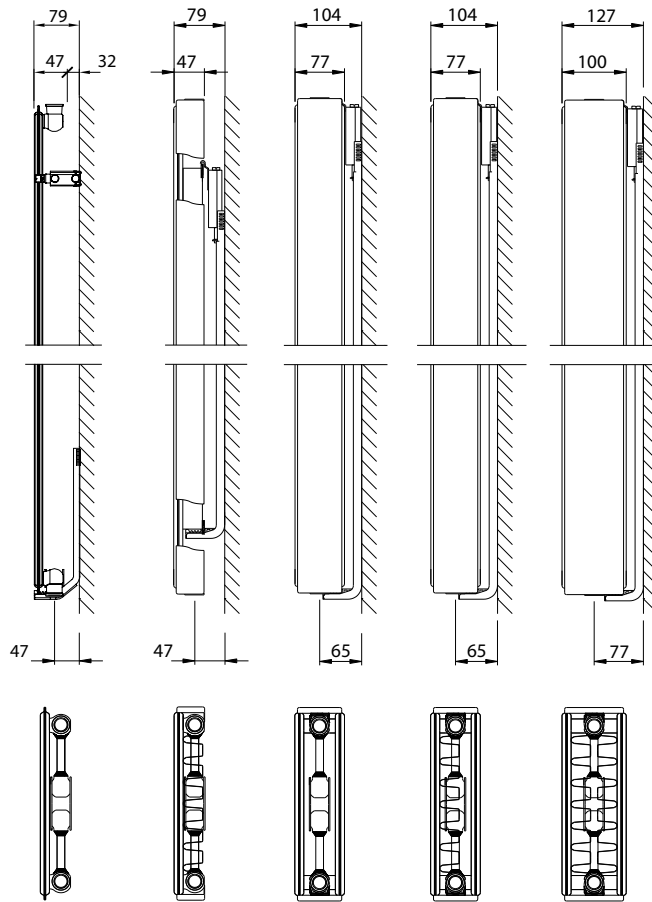

Height		Type 10	Type 11	Type 20	Type 21	Type 22	Height
1600	W	1.677	2.157	2.592	3.030	3.630	1600
	kg	30,90	42,90	63,30	71,70	80,70	
	l	7,20	7,20	14,40	14,10	14,10	
	m ²	3,67	9,40	7,33	12,66	28,99	
	n	1,27	1,34	1,32	1,32	1,33	
1800	W	1.863	2.379	2.865	3.330	3.960	1800
	kg	34,50	48,30	71,10	80,10	88,80	
	l	8,40	8,40	16,20	16,50	16,20	
	m ²	4,13	9,86	8,25	13,58	29,90	
	n	1,29	1,33	1,31	1,33	1,33	
2000	W	2.058	2.595	3.120	3.600	4.290	2000
	kg	38,10	53,70	78,60	89,10	96,60	
	l	9,30	9,30	18,00	18,60	18,00	
	m ²	4,59	12,15	9,17	16,20	37,74	
	n	1,30	1,33	1,31	1,33	1,33	
2200	W	2.265	2.802	3.390	3.870	4.620	2200
	kg	42,00	57,90	87,60	98,40	108,90	
	l	10,20	10,20	20,10	20,10	20,10	
	m ²	5,04	12,61	10,09	17,11	38,66	
	n	1,32	1,32	1,30	1,33	1,34	

W=heat output per meter / kg=weight per meter / l=content per meter / m²=surface per meter / n=exponent
The manufacturer reserves the right to alter any of the specifications shown in this document without prior notice.

VERTEX

Heat outputs in Watt (EN442)

- EN442 (W) 70/50/20°C
- EN442 (W) 55/45/20°C



On the label:

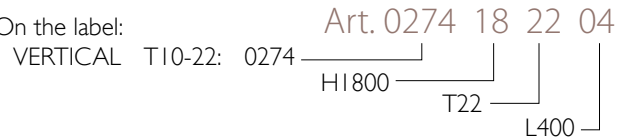

Stelrad BV/PL 1800-49/EC008

Height	1600					1800					2000					2200					Height
	Type	10	11	20	21	22	10	11	20	21	22	10	11	20	21	22	10	11	20	21	
300	378	480	579	677	810	419	530	642	743	883	461	578	699	803	956	507	626	761	862	1.028	300
	262	327	396	462	553	289	362	440	507	602	317	395	480	548	651	347	428	524	588	700	
	0274	0274	0274	0274	0274	0274	0274	0274	0274	0274	0274	0274	0274	0274	0274	0274	0274	0274	0274	0274	
400	505	641	772	902	1.080	559	707	855	991	1.177	615	772	932	1.070	1.274	675	834	1.015	1.150	1.371	400
	350	436	528	616	737	386	482	586	676	803	423	527	640	730	868	462	570	698	784	933	
	0274	0274	0274	0274	0274	0274	0274	0274	0274	0274	0274	0274	0274	0274	0274	0274	0274	0274	0274	0274	
500	631	800	965	1.128	1.350	699	884	1.068	1.238	1.471	769	965	1.165	1.338	1.593	844	1.043	1.268	1.437	1.714	500
	437	545	660	771	921	482	603	732	846	1.003	529	659	800	913	1.085	577	712	873	980	1.166	
	0274	0274	0274	0274	0274	0274	0274	0274	0274	0274	0274	0274	0274	0274	0274	0274	0274	0274	0274	0274	
600	757	960	1.158	1.353	1.620	839	1.060	1.282	1.486	1.765	923	1.158	1.399	1.606	1.911	1.013	1.251	1.522	1.725	2.057	600
	525	654	792	925	1.105	579	723	879	1.015	1.204	635	790	960	1.095	1.302	693	855	1.047	1.176	1.400	
	0274	0274	0274	0274	0274	0274	0274	0274	0274	0274	0274	0274	0274	0274	0274	0274	0274	0274	0274	0274	
700	883	1.121	1.351	1.579	1.890	978	1.237	1.496	1.734	2.060	1.077	1.350	1.632	1.873	2.230	1.182	1.459	1.775	2.012	2.399	700
	612	763	924	1.079	1.290	675	843	1.025	1.184	1.404	740	922	1.120	1.278	1.519	809	997	1.222	1.372	1.633	
	0274	0274	0274	0274	0274	0274	0274	0274	0274	0274	0274	0274	0274	0274	0274	0274	0274	0274	0274	0274	

Core assortment (Stelrad white 9016) available ex factory within 10 days.
Core assortment is subject to change, please refer to www.stelrad.eu for the latest information.
Delivery time depends on the model, please refer to your distributor.

CONNECTION POSSIBILITIES

View: front of radiator

Types 10 / 11 / 20 / 21 / 22

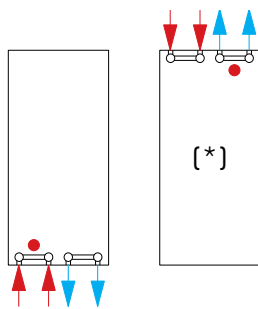

Types 20 / 21 / 22

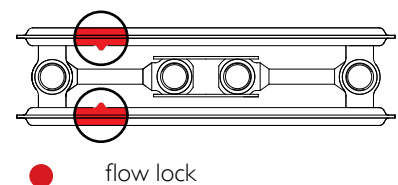
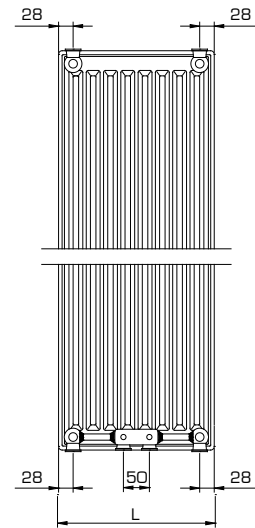
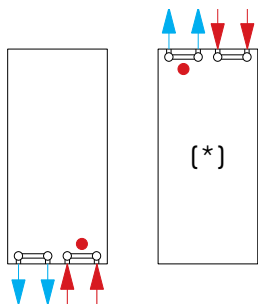

WALL BRACKETS

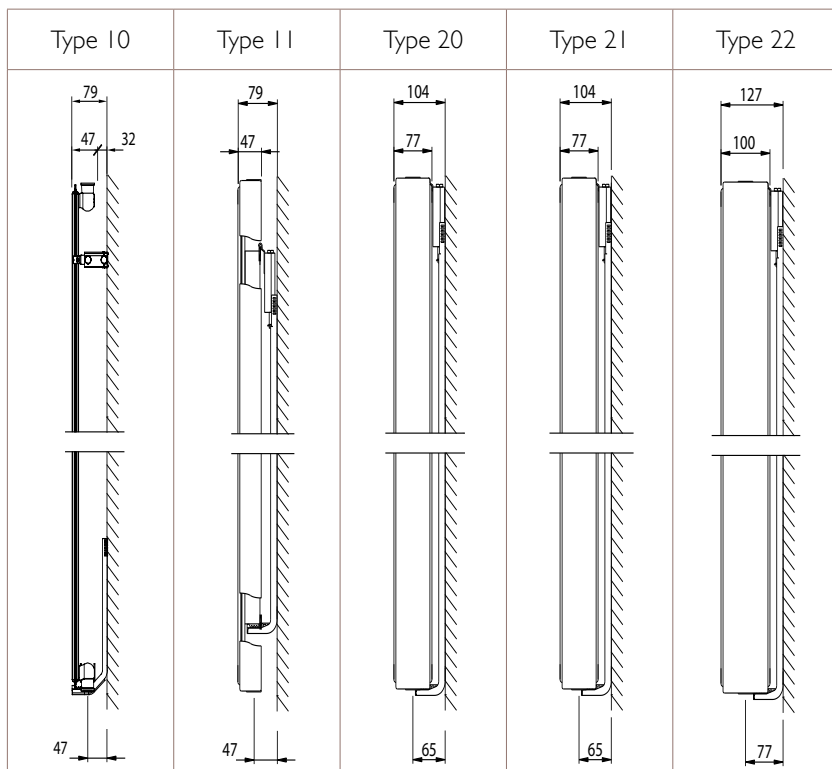

Nominal Height (mm)	Type 10			Type 11			Types 20-22		
	H2	H3	H4	H2	H3	H4	H2	H3	H4
1600	170	270	1500	160	730	1300	70	740	1410
1800	170	270	1700	160	830	1500	70	840	1610
2000	170	270	1900	160	930	1700	70	940	1810
2200	170	270	2100	160	1030	1900	70	1040	2010

Nominal Length (mm)	Type 10		Type 11	Types 20-22
	A	B	B	B
L 300	45	75	50	60
L 400	95	125	80	110
L 500	145	175	130	160
L 600	195	225	180	210
L 700	245	275	230	260

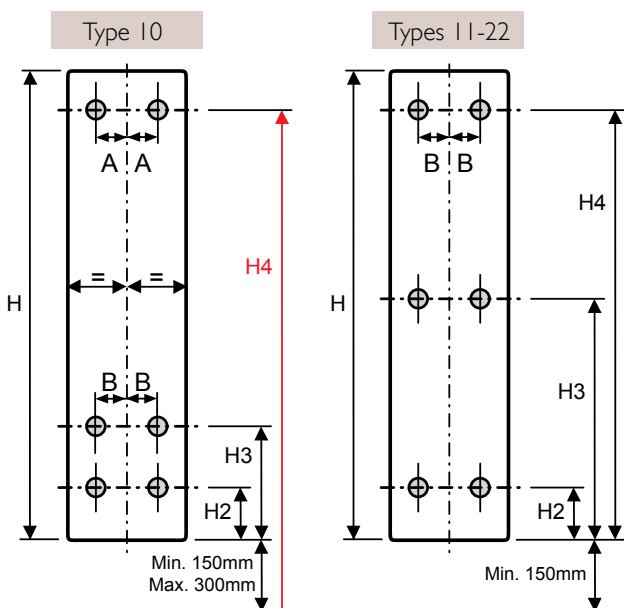

Always refer to the installation instructions and safety regulations before mounting a radiator!

An additional floor support for vertical radiators (types 20-22) is available for weak walls.

A professional inspection of the wall should always be conducted prior to mounting the radiator.

ATTENTION:

Always to be used in combination with the supplied wall brackets!

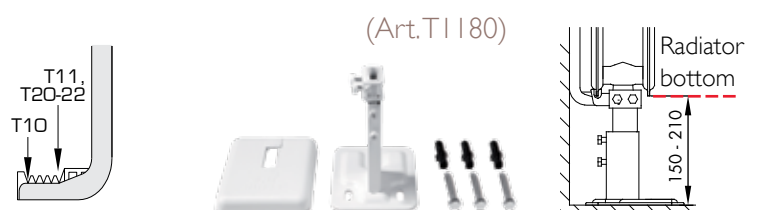

VALVED DESIGN CONNECTION FITTING

Specifications

- design cover
- design thermostatic head
- 2x 3/4" - 1/2" reduction
- 2x conical adapter
- Inlet on thermostatic head side
- valve with adjustable Kv (8 presettings)
- maximum operating temperature: 90°C
- maximum operating pressure: 6 bar
- maximum tightening torque: 35 Nm
- body in white high-quality plastic

The valve cannot be replaced.

For two-pipe systems, not suitable for one-pipe systems.



Design connection set straight piping with left or right handed valve (reversible)

Art. N°.T2121 - white

Art. N°.T2122 - chrome

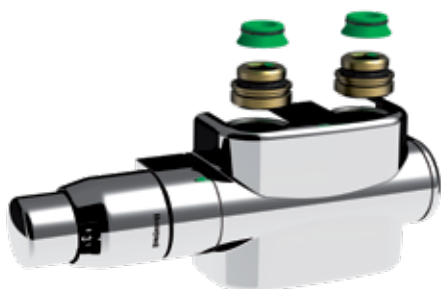

Design connection set angle piping with left handed valve

Art. N°.T2123 - white

Art. N°.T2124 - chrome



Design connection set angle piping with right handed valve

Art. N°.T2125 - white

Art. N°.T2126 - chrome



VALVED DESIGN CONNECTION FITTING

Adjustment of the valved connection fitting



Presetting	p-band xp 2,0 K	p-band xp 1,0 K
1	0,10	0,10
2	0,21	0,19
3	0,26	0,21
4	0,36	0,25
5	0,44	0,27
6	0,54	0,32
7	0,60	0,32
8	0,61	0,33

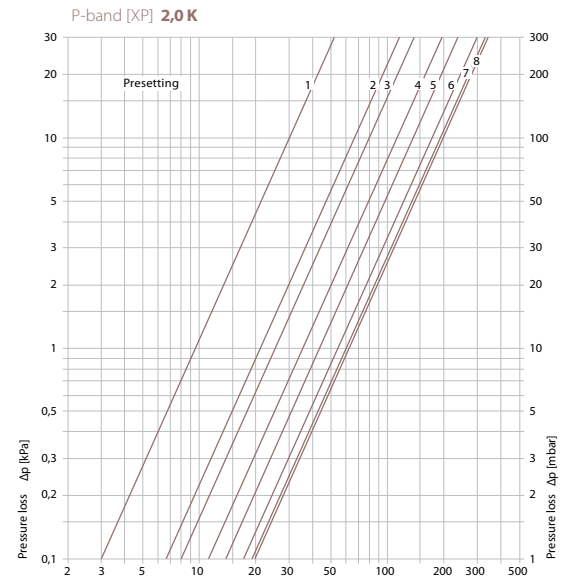
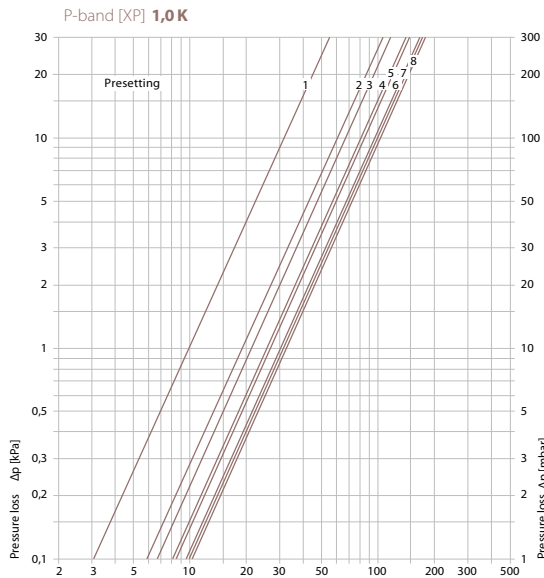

Lock function

The lock function can be used to lock the radiator without shutting down the heating system.

The valved design connection fitting closes the inlet and outlet by closing the closing screw and the thermostatic head.



Mounting dimensions

The supplied adapters enable the connection fitting to be fitted on the most commonly used connections: $\frac{3}{4}$ " external thread with flat sealing, $\frac{3}{4}$ " external thread Eurocone and $\frac{1}{2}$ " internal thread.

The mounting dimensions are also valid for the connection fittings without valve.

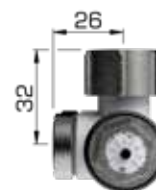

$\frac{3}{4}$ " external thread with flat sealing



$\frac{3}{4}$ " external thread Eurocone



$\frac{1}{2}$ " internal thread





Austria • Belarus • Belgium • Cyprus • Czech Republic • Estonia • France • Germany • Greece • Iceland • Ireland • Lithuania
Luxemburg • Norway • Poland • Portugal • Slovenia • Spain • Sweden • The Netherlands • Tunisia • Ukraine • United Kingdom

THE NETHERLANDS

Caradon Stelrad B.V. | Kathagen 30 | 6361 HG Nuth

WWW.STELRAD.EU

