



# Electric Towel Radiator



## User-/installation manual

Safety instructions	2
Positioning of the device	3
Installation of the device	3-4
Operation	5-11
User settings	12-14
Installer settings	14-16
Expert settings	17-19
Maintenance tips	20
Technical data	20-21



## Gebruikers-/montagehandleiding

Veiligheidsvoorschriften	24
Plaatsbepaling voor het apparaat	25
Installatie van het apparaat	25-26
Bediening	27-33
Gebruikersinstellingen	34-36
Installateursinstellingen	36-38
Expertinstellingen	39-41
Onderhoudstips	42
Technische gegevens	42-43



## Gebrauchs-/Installationsanleitung

Sicherheitshinweise	46
Positionierung des Gerätes	47
Einbau des Gerätes	47-48
Bedienung	49-55
Anwendereinstellungen	56-58
Installationseinstellungen	58-60
Experteinstellungen	61-63
Wartung-Tipps	64
Technische Daten	64-65



## Manuel d'utilisation/d'installation

Consignes de sécurité	68
Positionnement de l'appareil	69
Installation de l'appareil	69-70
Fonctionnement	71-77
Réglages utilisateur	78-80
Réglages installateur	80-82
Réglages expert	83-85
Conseils d'entretien	86
Données techniques	86-87

**SAFETY INSTRUCTIONS**

Please read these instructions carefully, in order to:

- ensure that your installation complies with applicable standards
- optimise your equipment's performance

We cannot be held liable for any damage arising as a result of incorrect installation or non-compliance with our instructions.

The installation of this device and any work conducted on its electrical components must be carried out by qualified personnel.

The electrical installation must comply with local and national applicable regulations. Due to the absence of a plug, it is imperative to provide a way to disconnect the wires of the permanent wiring according to the installation rules.

**WARNING:** This device is not designed to bear the weight of a person, and no one should therefore climb onto it.

This device is designed solely to dry laundry that has been washed with water.

The radiator is designed to be wall-mounted, and must not be located directly under an electrical outlet. If the power cable is damaged, it must be replaced by us, our after-sales service or people of similar qualifications to avoid danger.

The heater contains a specific amount of fluid. Any repairs requiring the heater to be opened should be carried out by the manufacturer or by his maintenance representative. All leaks must be repaired by the manufacturer or his representative. All anomalies must be immediately corrected to ensure the safety of the installation and of the user. Should any problem arise, please contact our after-sales service.

Please keep away from children aged less than 3, unless they are under permanent supervision.

Children aged 3 to 8 are only permitted to turn the device on or off if the device has been placed or installed in a normal position, and if the children are supervised or have been taught how to use the device safely, and understand the potential dangers. Children aged 3 to 8 should not connect, set or clean the device, and should not perform maintenance tasks normally carried out by the user.

This device can be used by children aged 8 or more, and by persons whose physical, sensory or mental capacities are reduced, or who have no knowledge or experience of the device, if such persons are properly supervised, or if they have been instructed as to the safe use of the device, and if all potential risks have been properly understood. Children should not play with the device. Cleaning and maintenance work conducted by the user must not be carried out by unsupervised children.

**WARNING :** To prevent all risks for very young children, the device should be installed so that the lowest heated tube is at least 600 mm off ground level. Some parts of this product can become very hot and cause burns.

Attention should be particularly paid in the presence of children and vulnerable persons.

**POSITIONING THE DEVICE**

**In the bathroom**

This is a class II heater with an IP44 protection rating and, as such, it can be installed in volume 2 of the bathroom (see figures 1a and 1b), provided that it is shielded from water splashes.

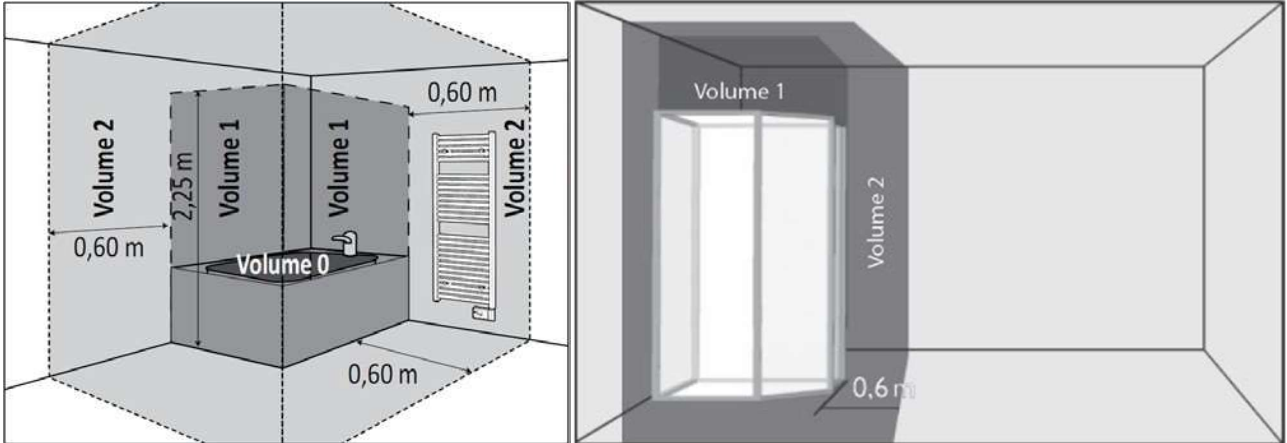

**Automatic open window detection**

See “Operation” – Open window detection

**INSTALLING THE DEVICE**

**Content of the package**

- Radiator, factory-filled and fitted with a heating element
- Factory-mounted control box
- Consoles
- Screws and wall plugs
- Installation and user manual

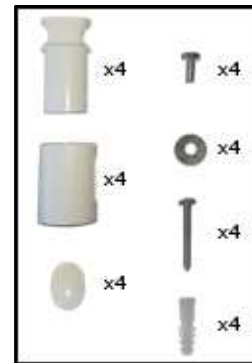
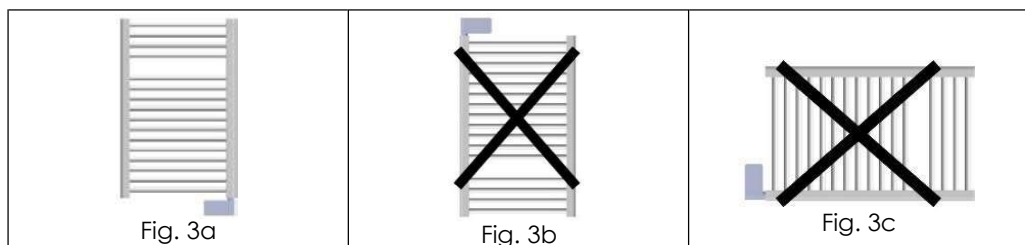

Fig. 2

**Installation**

The radiator must be installed with the heating element vertical and the control box in the lower section (figure 3a).

It is prohibited to install the device with the control box in the upper section (figure 3b) or with the heating element horizontal (figure 3c).



Drill the mounting holes, insert the plugs in the holes, secure the wall supports to the wall and install the heater on its supports (see figure 4). Use screws and plugs that are adapted to your kind of wall.

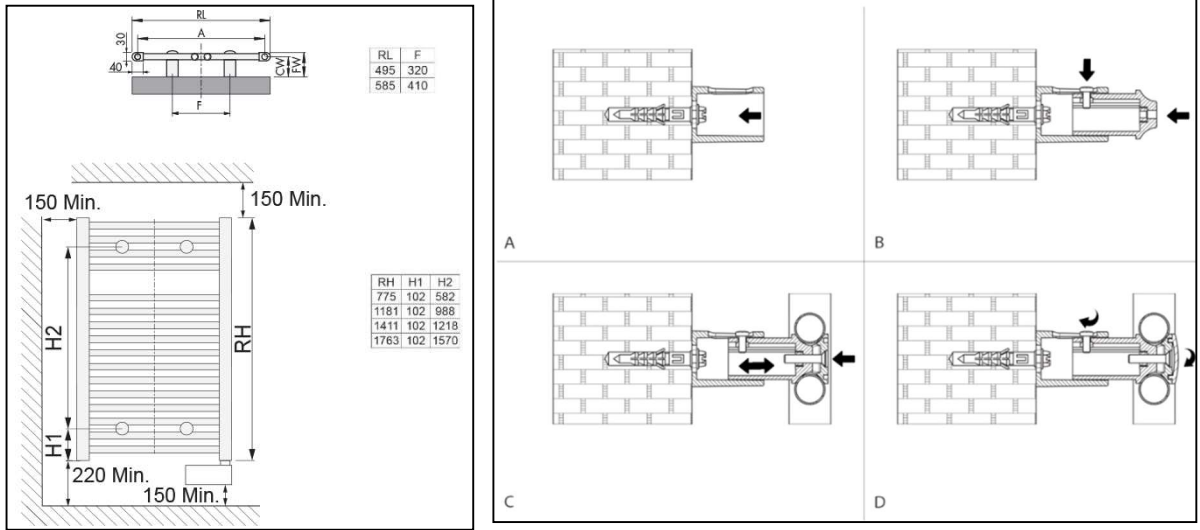

Fig.4

**Electrical connection**

As this equipment is fixed and not movable, the power supply to the radiator must be directly connected to the network behind the omnipolar disconnect device in accordance with the installation rules.

When installed in a bathroom, it must be safeguarded with a differential switch of 30 mA.

The device is class II insulated and, therefore, it cannot be earthed. The device should be powered by a single-phase current of 230V~ 50 Hz.

Connect the three main cables as follows:

- Brown wire = phase
- Blue wire = neutral
- Black wire = pilot wire

**WARNING:** the pilot wire must be insulated if it is not used.

In the event of a faulty controller, it should be replaced with an identical model. To find the right model, please contact your wholesaler. Replacing the control box with another model voids the guarantee and renders the device non-compliant with safety standards.

# OPERATION

## DIAGRAM POWER ON/STANDBY MODE

### Buttons overview

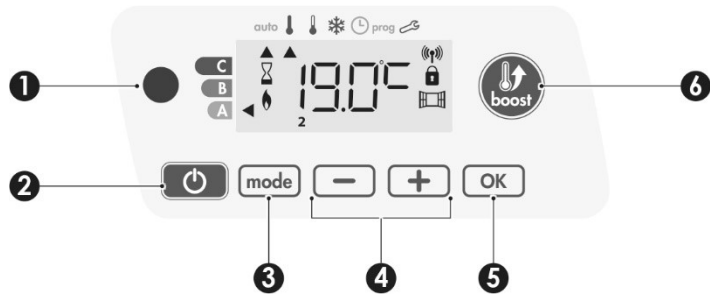

- 1 Infrared receiver
- 2 Button power on/standby mode
- 3 Selecting operating modes
- 4 Set temperatures, time, date and 2 programmes
- 5 Save settings
- 6 Boost

### Indicators overview

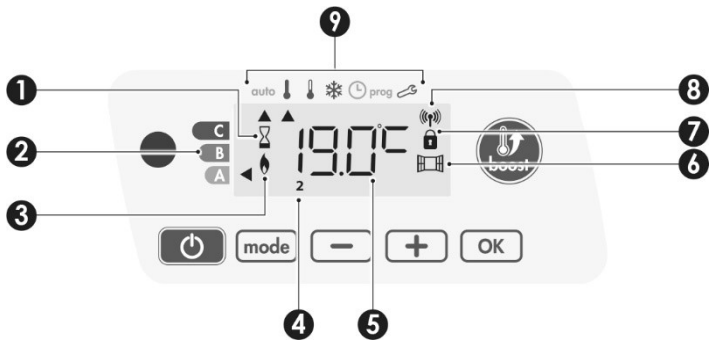

- 1 Boost indicator light
- 2 Gauge consumption
- 3 Heating indicator
- 4 Days of the week (1=Monday, 7=Sunday)
- 5 Setting temperature
- 6 Open window detection indicator
- 7 Keypad locked
- 8 Radio transmission indicator
- 9 **Operation modes:**
  - auto Auto mode
  - ! Comfort mode
  - ! Eco mode
  - \* Frost protection mode
  - 🕒 Time and date setting mode
  - prog Programming mode
  - 🔧 Settings

**Important:** In Auto, Comfort, Eco and Standby mode, backlight turns off automatically after 20 seconds if no buttons are pressed. It will be necessary to reactivate it by pressing one of the keypad buttons before making settings.

**Note**  
Before carrying out any setting procedures, ensure that the keypad is indeed unlocked (see "KEYPAD LOCK/UNLOCK").

### Power on feature

Press the button to put the device in operation, in Auto mode.

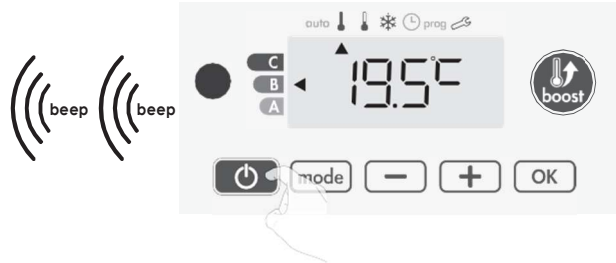

### Help for the visually impaired: sound signals

The device makes 2 short beeps to notify that it is in operation, in Auto mode.

### Standby mode

This function allows you to stop the heating in summer, for example. Press the button to put the device in standby mode.

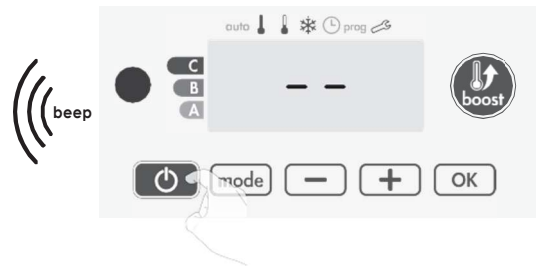

### Help for the visually impaired: sound signals

The device makes 1 short beep to notify that it is in standby mode.

## SELECTING THE OPERATING MODE

The button allows you to adapt the operating schedule of your device to your needs, depending on the season, whether your home is occupied or not.

Press the button several times to select the required mode.

### Mode sequence:

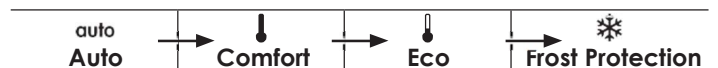

### Mode overview Display

#### • auto Auto mode

In Automatic Mode, the device will automatically change from Comfort mode to Eco mode according to the established programme.



#### 3 different cases depending on your set-up:

##### 1 7 day and daily programme

Your device has been programmed and is executing Comfort and Eco mode orders in line with the settings and time periods you have selected (see "7 day and daily programme integrated" chapter).

Mode overview

Display

2 Programming by pilot wire

If you do not want to use the programming feature, the device's default setting is non-stop Comfort for 7 days a week, you do not have to change any settings. Orders sent by the pilot wire will only be applied in Auto mode, thus your device will automatically receive and apply the programmed orders sent by your power manager or your time switches (see Information about remote control by pilot wire).

3 Without programme

if the 7 day and daily programme is not enabled or no orders are being sent by pilot wire, then your device's factory settings mean that it will operate in nonstop Comfort mode, 7 days of the week.

Comfort mode

Non-stop Comfort mode. The device will operate 24 hours a day to achieve the temperature which has been set (e.g. 19°C). The Comfort mode temperature level can be set by the user (see Setting the comfort mode temperature).



Eco mode

Eco, which means the Comfort Mode temperature minus 3.5°C. This enables you to lower the temperature without having to reset the Comfort Mode temperature. Select this mode for short term absences (between 2 and 24h) and during the night.



Frost protection mode

This mode enables you to protect your home against the effects of cold weather (frozen pipes, etc.), by maintaining a minimum temperature of 7°C in it at all times. Select this mode when you will be away from your home for a long time (more than 5 days).



Restoring factory settings See "Operation" – Restoring factory settings

BOOST FEATURE

Important: the Boost mode can be enabled at any time, whatever the current operating mode (Auto, Comfort, Eco or Frost protection).

To activate Boost mode, press the boost button, the desired temperature setting will be set at maximum for the time period you request. 60 minutes display will flash by default.

- First press = Boost.

During the first minute: the boost symbol and the heating indicator appear and the duration count flash.



During the first minute, you can modify the Boost duration from 0 to the maximal authorised duration of the Boost, such as defined during the user settings by intervals of 5 minutes (or more quickly by push superior to 2 seconds) by pressing the minus and plus buttons. This modification will be saved and effective for the next Boost.

After 1 minute, the Boost count begins and the time is running, minute by minute.

Comment: After 1 minute, you can modify temporarily the duration: it will be valid only for this active Boost and therefore non-recurring.

The Boost can stop for 2 different reasons:

- An order "Stop" has been sent by your energy manager through the pilot wire:

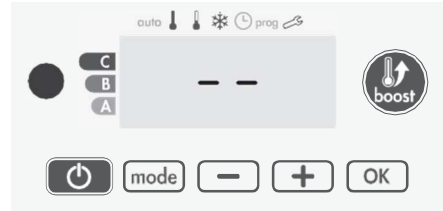

The device stops, -- appears. The cursor moves above auto. When the order Comfort will be sent, the device will be restarted until the count end.

- If the ambient temperature reaches the maximal Boost temperature during the count:



The device switches off but the Boost mode is always active: the count is always displayed, the Boost symbol and the heating indicator flash on the display. When the temperature drops under the maximal authorised temperature, the device will be restarted until the count ends.

- Second press = Boost cancellation.

The cursor moves above the previous active mode and the setting temperature appears.

GAUGE CONSUMPTION, ENERGY SAVINGS

France's Agency for Environment and Energy Management (ADEME) recommends a Comfort setting temperature lower or equal to 19°C.

In the device display, a selector indicates the energy consumption level by positioning it in front of the colour: red, orange or green. So, depending on the setting temperature, you can choose your level of energy usage. As the temperature setting increases, the consumption will be higher.

The gauge appears in Auto, Comfort, Eco and Frost protection modes and whatever the temperature level.

<p><b>C - Red colour</b> High Temperature level: it is advisable to significantly reduce the setting temperature.</p>	<p><b>Setting temperature &gt; 22°C</b> When the setting temperature is higher than 22°C</p>	
<p><b>B - Orange colour</b> Average temperature level: it is advisable to slightly reduce the setting temperature.</p>	<p><b>19°C &lt; Setting temperature ≤ 22°C</b> When the setting temperature is higher than 19°C and lower or equal to 22°C</p>	

**A - Green colour** Ideal temperature.

**Setting temperature  $\leq 19^{\circ}\text{C}$**   
When the setting temperature is lower or equal to  $19^{\circ}\text{C}$



## SETTING THE COMFORT MODE TEMPERATURE

You can access the Comfort temperature set up from the Auto and Comfort Mode. It is preset to  $19^{\circ}\text{C}$ .

Using **-** and **+** you can adjust the temperature from  $7^{\circ}\text{C}$  to  $30^{\circ}\text{C}$  by intervals of  $0.5^{\circ}\text{C}$ .



**Note:** you can limit the Comfort temperature, see "USER SETTINGS" for more details.

## CONSUMPTION INDICATION ACCUMULATED IN KWH, ENERGY SAVINGS

It is possible to see the estimation of energy consumption in kWh since the last reset of the energy meter.

### Display of the estimated power consumption

To see this estimation, from Auto, Comfort, Eco or Frost protection mode, then press **OK**.



To exit the display mode of consumption: press any button, the device is automatically in the previous active mode.

### Resetting the energy meter

To reset the energy meter, from Auto, Comfort, Eco or Frost protection mode, then proceed as follows.

- 1- Press **OK**.
- 2- Press simultaneously **-** and **+** for more than 5 seconds.  
To exit resetting the energy meter, press any button, the device is automatically in the previous active mode.

## CHILD ANTI-TAMPER, KEYPAD LOCK/UNLOCK

### Keypad lock

To lock the keypad, press the **-** and **+** buttons and hold them down for 10 seconds. The padlock symbol  appears on the display, the keypad is locked.



### Keypad unlock

To unlock the keypad, press the **-** and **+** buttons hold them down for 10 seconds again. The padlock symbol  disappears from the display, keypad is unlocked.



### When keypad is locked, only the key is active.

If the device is on Standby mode when the keypad is locked, you have to unlock it for the next heating on to access the setup.

## 7 DAY AND DAILY PROGRAMME INTEGRATED, ENERGY SAVINGS

In this mode, you have the option of programming your device, by setting one of the five programmes on offer for each day of the week.

### Access to the programming mode

From Auto, Comfort, Eco or Frost protection mode, press **mode** for 5 seconds to enter into the programming mode.

### Schematic sequence of programming settings:



### Setting day and time

In this mode, you can set day and time to program your device in line with your needs.

- 1- From Auto, Comfort, Eco or Frost protection mode, press **mode** for 5 seconds.  
The cursor moves to the setting day and time mode.



5 sec.

- 2- Select using **-** or **+**. The two hour figures will flash. The hours will scroll quickly, if you press the **-** or **+** and hold them. Save by pressing **OK**.

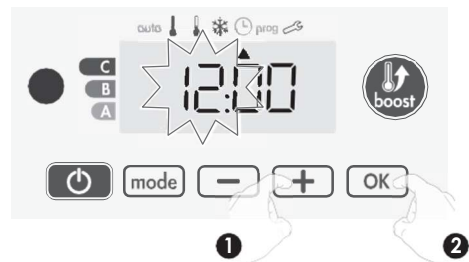

- 3- The two minute figures will flash. Select using **-** or **+**. Save by pressing **OK**.

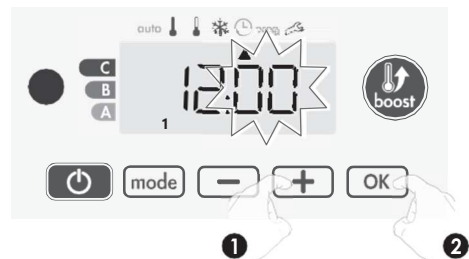

- 4- The cursor above the number 1 (which represents the Monday) will flash. Select the date using **-** or **+**. Save by pressing **OK**.

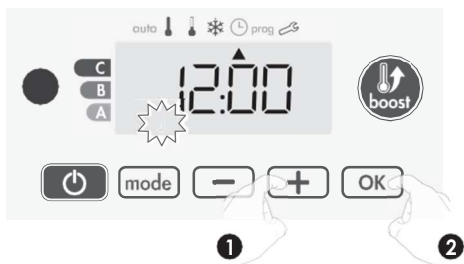

- 5- To change and/or allocate programmes press **mode**. To exit the setting the time and day mode, press **mode** 3 times.

**Choices programmes**

Schematic sequence of programmes:

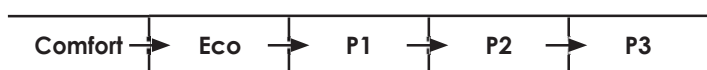

Your device's default setting is non-stop Comfort for 7 days a week.

**Programmes overview**

- **Comfort:** your device will operate in Comfort mode, 24 hours a day, as regards each day selected.  
**Note:** You can set the Comfort mode temperature to the temperature you require (see Setting the comfort mode temperature).
- **Eco:** The device will operate 24 hours a day in Eco mode.  
**Note:** You can set the temperature-lowering parameters (see Setting the Eco mode temperature lowering-level).
- **P1:** your device will operate in Comfort mode from 06:00 to 22:00 (and in Eco mode from 22:00 to 06:00).
- **P2:** your device will operate in Comfort mode from 06:00 to 09:00 and from 16:00 to 22:00 (and in Eco mode from 09:00 to 16:00 and from 22:00 to 06:00).
- **P3:** your device will operate in Comfort mode from 06:00 to 08:00, from 12:00 to 14:00 and from 18:00 to 23:00 (and in Eco mode from 23:00 to 06:00, from 08:00 to 12:00 and from 14:00 to 18:00).

**Potential modifications of programmes**

If the default time schedules for the P1, P2 and P3 programmes does not suit your routines, you can change them.

**Modifying the P1, P2 or P3 programmes.**

**If you modify the time schedules for the P1, P2 or P3 programmes, the schedules will be modified for all the days of the week for which P1, P2 or P3 had been set.**

- 1- If you just set the time and day, go to step 2.  
From Auto, Comfort, Eco or Frost protection mode, press **mode** for 5 seconds.  
When the cursor moves above the setting times symbol ⌚, press **mode** shortly.



- 2- Press **-** or **+**. The cursor moves above **prog**.

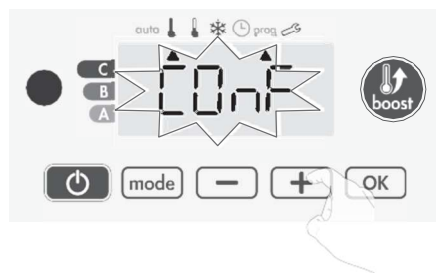

- 3- With **-** or **+**, select P1. P1 will flash. Press **OK** for 5 seconds to make changes.

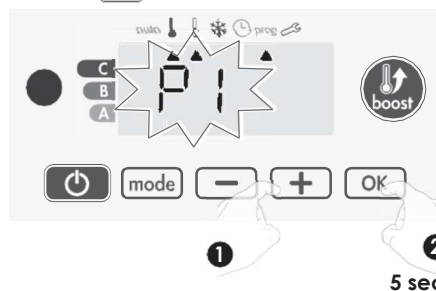

- 4- The P1 start time (which by default is 06:00) will flash. Using **-** or **+**, you can change this time, by increments of 30 minutes.



Save by pressing **OK**.

- 5- The P1 end time (which by default is 22:00) will flash. Using **-** or **+**, you can change this time, by increments of 30 minutes.

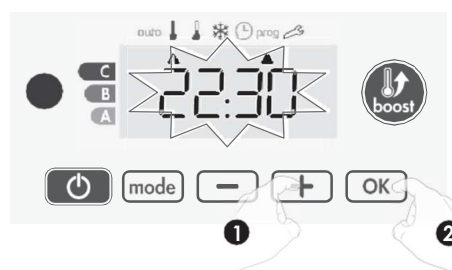

Save by pressing **OK**.

- 6- Press **mode** to exit the programming Mode and return to Auto Mode.

**Note:** without action on the keys, it will return to Auto after a few minutes.



**● Choices and allocation programmes**

1- If you just set the time and day, the cursor moves automatically under **PROG.**

From Auto, Comfort, Eco or Frost protection mode, then press **[mode]** for 5 seconds. When the cursor positioned under the set time symbol ⌚, press **[mode]** again.

**Prior information:**  
display area



Correspondence days / numbers	
Monday	1
Tuesday	2
Wednesday	3
Thursday	4
Friday	5
Saturday	6
Sunday	7

The days of the week will scroll on display with the programmes that you set for them, meaning Comfort **CONF** every day.



2- Press **[-]** or **[+]**.

The programme set for day 1 (1=Monday, 2=Tuesday, etc.) will flash.



3- Chose the programme you want for this day with **[-]** or **[+]**.

Save by pressing **[OK]**.

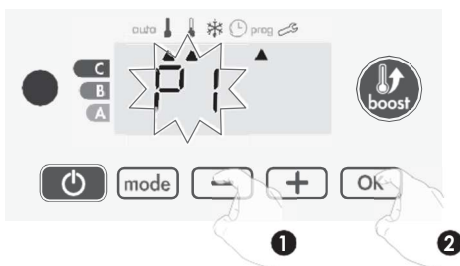

4- The program assigned to the second day of the week (Tuesday) will flash.

Repeat the procedure described previously (in point 3) for each day of the week.

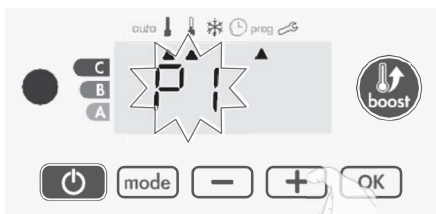

5- Once you have chosen a programme for each day, confirm your selection by pressing **[OK]**. The days of the week will successively scroll on display with the programmes that you set for them (P1, P2, P3, CONF or ECO).

To exit the Programming mode, press **[mode]** twice.

**● Viewing the programmes that you have selected**

- From Auto, Comfort, Eco or Frost protection mode, press **[mode]** for 5 seconds. Press **[mode]** twice, the programme for each day of the week (Comfort, Eco, P1, P2 or P3) will scroll on display in front of you.

- To exit the programme viewing mode, press **[mode]** twice.

**● Manual and temporary exemption from a running programme**

This function allows you to change the setting temperature temporarily until the next scheduled change in temperature or the transition to 0:00.

**Example:**

1- The device is in Auto mode, the running programme is Eco 15,5°C.



2- By pressing **[-]** or **[+]**, you can change temporarily the desired temperature up to 18°C for example.



**Note:** The cursor corresponding to the operating mode, i.e Eco mode in our example, is blinking during the duration of the temporary derogation.

3- This change will be automatically cancelled at the next change of programme or transition to 0:00.

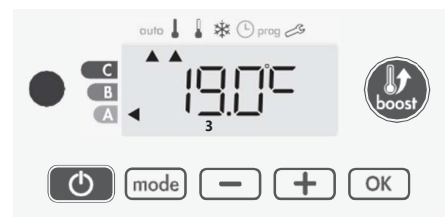

**OPEN WINDOW DETECTION, ENERGY SAVINGS**

**● Important information about the open window detection**

**Important:** the open window detection is sensitive to temperature variations. The device will react to the window openings in accordance with different parameters: temperature setting, rise and fall of temperature in the room, outside temperature, location of the device...

If the device is located close to a front door, the detection may be disturbed by the air caused by opening door. If this is a problem, we recommend that you disable the automatic mode

open window detection (see Expert Settings). You can, however, use the manual activation (see below).

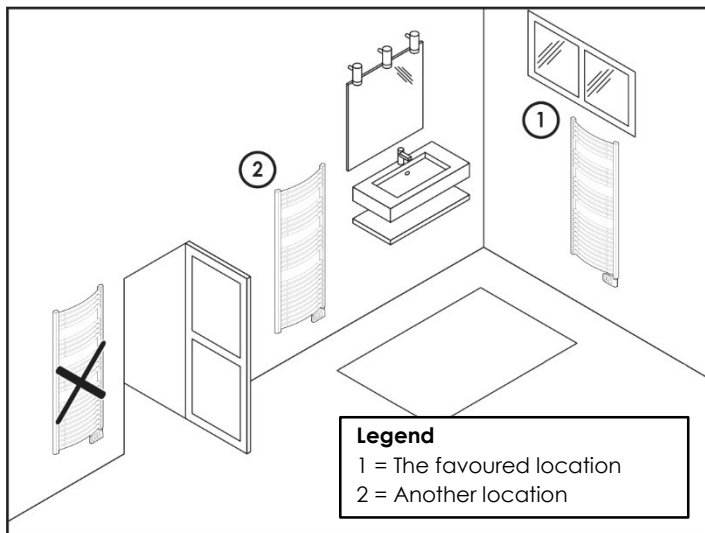

• Overview

Lowering temperature cycle by setting frost protection during ventilation of a room by opened window. You can access the open window detection from the Comfort, Eco and Auto modes. Two ways to enable the detector:

- **Automatic activation**, the lowering temperature cycle starts as soon as the device detects a temperature change.
- **Manual activation**, the cycle of lowering temperature starts by pressing a button.

• Automatic activation (factory settings)

To disable this mode, see expert settings. The device detects a temperature fall. An opened window, a door to the outside, can cause this temperature fall.

**Note:** The difference between the air from the inside and the outside must cause a significant temperature fall to be perceptible by the device.

This temperature drop detection triggers the change to Frost Protection mode.

• Manual activation

By pressing for more than 5 seconds, the device will switch on Frost protection mode.

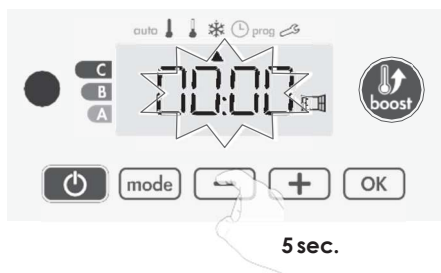

• Frost protection digital meter

When the device performs a lower temperature cycle due to opened window, a meter appears on the display to show the cycle time. The counter is automatically reset at the next time to Frost protection by opened window (automatic or manual activation).

• Stop the Frost protection mode

By pressing one button, you stop the Frost protection mode.

**Note:** if a temperature rise is detected, the device may return to the previous mode (active mode before the open window detection).

**INFORMATION ABOUT REMOTE CONTROL BY PILOT WIRE**

• Overview

Your device can be controlled by a central control unit through a pilot wire, in which case the different operating modes will be remotely enabled by the programmer.

You can only control the device by pilot wire in the Auto mode. In the other modes, the orders transmitted by the pilot wire will not be executed.

In general, a pilot wire control system makes it possible to impose externally a lowering of the temperature setpoint, combined with the internal programming and the occupancy detection. If several lowering requests appear simultaneously, priority is given to the lowest temperature setpoint, thus maximizing savings (see information on priorities for different modes). When a signal is sent from the pilot wire, the self learning optimization function is suspended.

Below the different views of the display for each order sent by pilot wire:

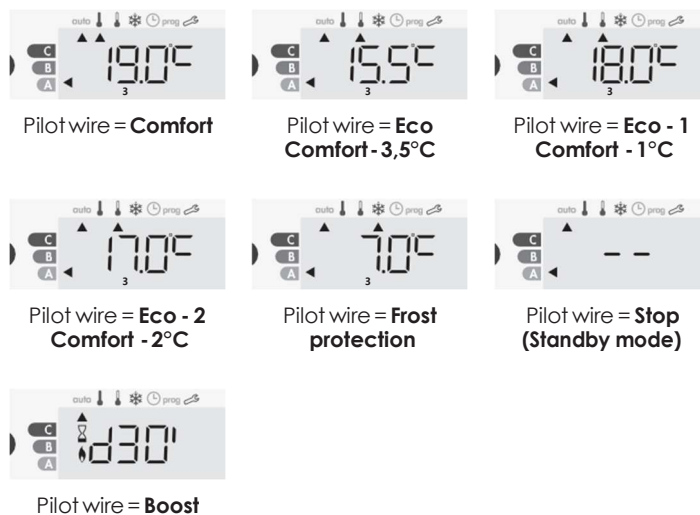

• Load shedding

In case of over consumption, an energy power manager or a disconnector doesn't trigger a trip of the general circuit-breaker (example: simultaneous operating of your various household appliances and others).

This allows you to reduce the energy powers subscribed and therefore optimize your subscription with your energy provider.

IMHOTEP creation controllers are designed to operate with **pilot wire load shedding systems**.

Orders sent by the pilot wire are executed by the device's electronic controller which will apply the setpoint corresponding to the order sent.

The "Stop" order corresponds to the load shedding. When this order is received, the device switches to "standby" and then returns to the initial operating mode.



**Important: Do not use load shedding by a power fail. Unlike pilot shedding, this type of shedding results in a series of sudden and frequent power cuts, which cause premature wear of the device or even deterioration not covered by the manufacturer's warranty.**

● **Exemption to an order coming from a pilot wire external programmer**

This feature allows you to modify temporarily the setting temperature until the next order sent by the central control unit or the transition to 00:00.

**Example:**

1- The device is in Auto mode. The central control unit sent an Eco order 15,5°C.



2- By pressing **-** or **+**, you can change temporarily the desired temperature up to 18°C for example.



**Note:** The cursor corresponding to the operating mode, i.e Eco mode in our example, is blinking during the duration of the temporary derogation.

3- This modification will be automatically cancelled at the next order sent by the central control unit or the transition to 00:00.



**INFORMATION ABOUT PRIORITIES BETWEEN THE DIFFERENT MODES**

● **Principe**

**In Comfort, Eco and Frost protection modes**, only orders of the open window sensor will be considered.

**In Auto mode**, the device can receive different orders coming from :

- 7 day and daily programming integrated (Comfort or Eco orders);
- 6-order pilot wire, if connected to central control unit;
- Open window detector.

**In general, it is the lowest received order which prevails except when the pilot wire is connected to an energy management system, in this case the orders of the pilot wire take priority. In case of programmed Boost, the Boost activation will take precedence over others orders received except when the standby (stop) order is present on the pilot wire, the device will switch off and the Boost will be not activated.**

● **Examples**

- + 7 day and daily programming = Comfort
- + Pilot wire 6 orders = Eco

**= Eco**



- + 7 day and daily programming = Eco
- + Pilot wire 6 orders = Stop (standby mode)
- + Open window detector = Frost protection

**= Standby mode**

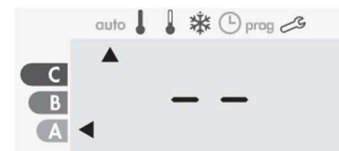

**OPTIONAL: REMOTELY MANAGEMENT BY INFRARED REMOTE CONTROL**

Your towel rails can be managed by a remote control with infrared transmission through its IR receiver located on the front of the controller.

● **Diagram**

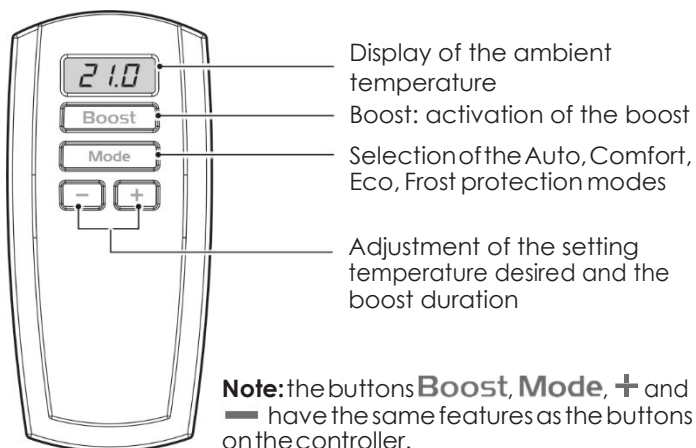

● **Operation**

Position the remote control toward the infrared receiving window of the device. Check that there is no obstacle between the remote control and the infrared receiver to disturb the transmission.

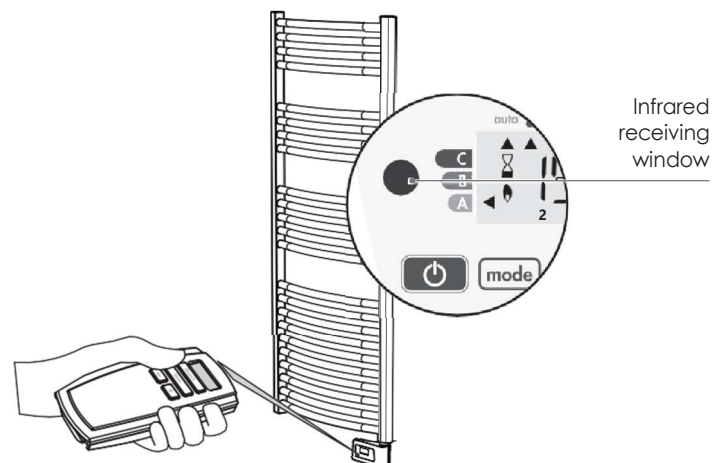

# USER SETTINGS

## ACCESS

You access to user settings in 3 steps:  
From Auto, Comfort, Eco or Frost protection mode :

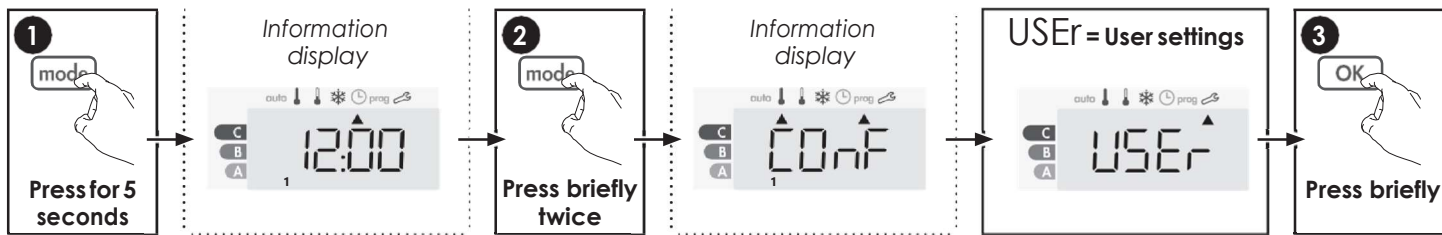

### Setting sequence:

Backlighting > Eco mode temperature lowering-level > Frost protection temperature > Comfort setting temperature limit > Maximal Boost duration > Maximum ambient temperature > Temperature unit

## BACKLIGHT SETTING

1- Three modes can be set:

- L1 = Temporary backlighting: Backlight of the display when a button is pressed.
- L2 = Non-stop backlighting: Backlight of the display all the time.
- L3 = In this version, the device will work according to the L1 mode.

L3 mode is the default setting.

Press **-** or **+** to choose the setting you require.

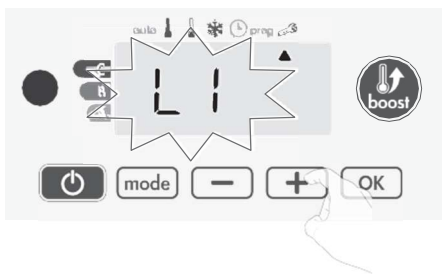

2- Press **OK** to save and move to the next setting.

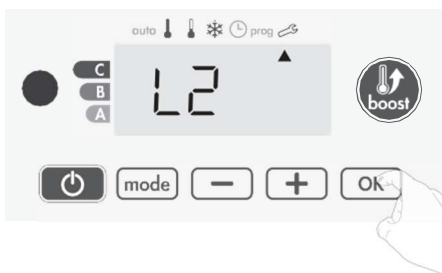

To exit the user settings, press **mode** twice.

## SETTING THE ECO MODE TEMPERATURE LOWERING-LEVEL

The drop in temperature is set at -3.5°C compared to the set temperature of the Comfort mode. You can adjust the lowered level from -1°C to -8°C, by intervals of 0.5°C.

**Important: whatever the lowering level set, the Eco setting temperature will never exceed 19°C.**

3- Press **-** or **+** to obtain the temperature level you require.

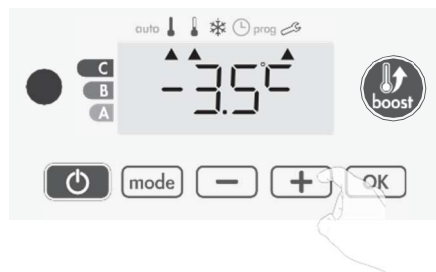

4- Press **OK** to save and move to the next setting.

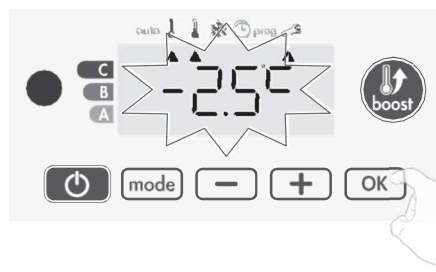

To exit the user settings, press **mode** twice.

## SETTING THE FROST PROTECTION TEMPERATURE

Your device is preset at 7°C. You can adjust the Frost protection temperature from 5°C to 15°C, by intervals of 0.5°C.

5- Press **-** or **+** to obtain the temperature you require.



6- Press **OK** to save and move to the next setting.  
To exit the user settings, press **mode** twice.

## COMFORT SETPOINT TEMPERATURE LIMIT

You can limit the setting temperature range by introducing a maximum and / or minimum setting, preventing unintentional changes in temperature.

### • Low temperature limit

Locking of the setting range using a minimum temperature stop, preventing the temperature from being set below that temperature.

The minimum setting is preset to 7°C. You can adjust from 7°C to 15°C by intervals of 1°C.

7- To change the minimum temperature setting, press **-** or **+** then save by pressing **OK**.

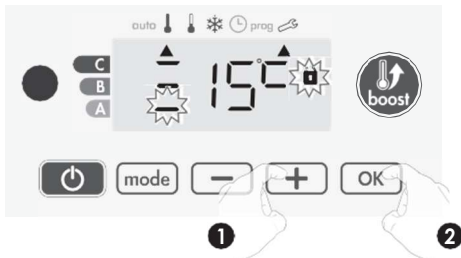

If you do not want to change it, press **OK**: the device changes automatically to set the maximum setting. To exit the user settings, press **mode** twice.

### • High temperature limit

Locking of the setting range using a maximum temperature increase, preventing the temperature from being set above that temperature.

The maximum setting is preset to 30°C. You can adjust from 19°C to 30°C by intervals of 1°C.

8- To change the maximum temperature setting, press **-** or **+**.

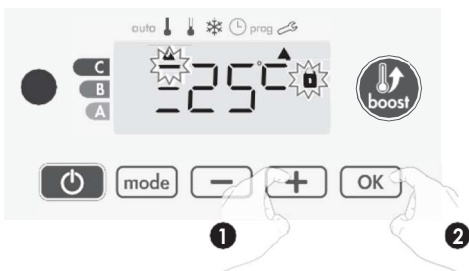

To save and move automatically to the next setting, press **OK**. To exit the user settings, press **mode** twice.

## SETTING OF THE MAXIMUM DURATION OF AUTHORISED BOOST

The maximum duration of Boost is preset at 60 minutes. You can adjust it from 30 to 90 minutes by intervals of 30 minutes.

9- The Boost symbol and the heating indicator appears on the display and the preset duration of 60 minutes flash.



10- Press **-** or **+** to display the desired duration.

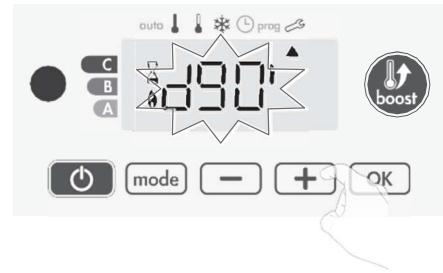

11- To save and move automatically to the next setting, press **OK**.



To exit the user settings, press **mode** twice.

## SETTING OF THE MAXIMUM AMBIENT TEMPERATURE FOR THE AUTOMATIC STOP OF THE BOOST

When the Boost is enabled, the device has to heat the room until the temperature limit: the maximum ambient temperature. When it is reached, the Boost stops automatically. It is preset at 39°C, you can adjust it from 25°C to 39°C by intervals of 1°C.

The Boost symbol and the heating indicator appear on the display and the maximum temperature flashes.

12- You can set the Boost maximum temperature by pressing **-** or **+** from 25°C to 39°C by intervals of 1°C.

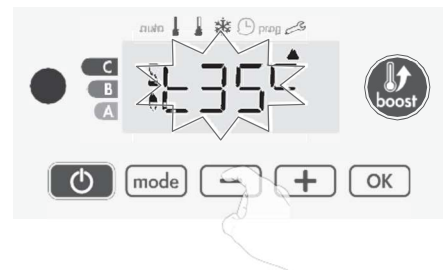

13- To save and move automatically to the next setting, press **OK**. To exit the user settings, press **mode** twice.

## SETTING THE TEMPERATURE UNIT

The pre-set temperature unit is degrees Celsius.

14- Press **-** or **+** to change the temperature unit.

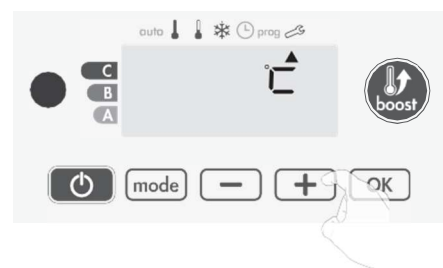

15- To save and move automatically to the next setting, press **OK**.

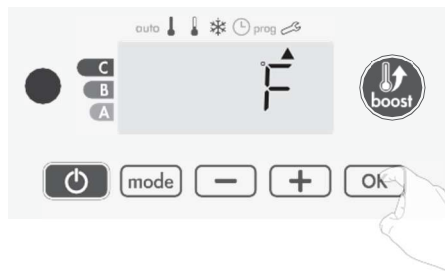

To exit the user settings, press **mode** twice.

### RESTORING FACTORY SETTINGS

In order to a coming back to factory settings, proceed in the following order:

1- From the setting of the temperature unit, press **OK**. **rESt** appears on the display.



2- **nO** appears. Press **-** or **+** to select **YES**.

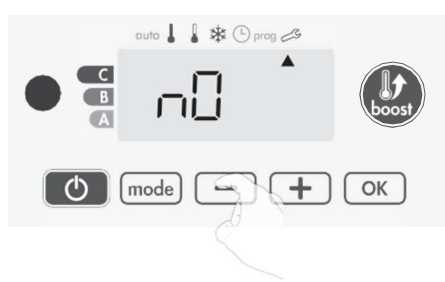

**yES** = Factory settings reset

**nO** = Factory settings not reset

3- Press the key **OK** for 5 seconds. The device returns to its initial configuration and goes back automatically to the home display of the user settings.



The following factory values will be effective:

Parameters	Factory settings
<b>Operating</b>	
Comfort setting temperature	19°C
Boost duration	60 min.
Keypad lock	Disabled
<b>User settings</b>	
Backlighting	L3
Eco mode temperature lowering-level	-3,5°C
Frost protection temperature	7°C
Minimum set of Comfort setting temperature	7°C
Maximum set of Comfort setting temperature	30°C
Maximal Boost duration	60 min.
Maximum ambient temperature for the automatic stop of the Boost	39°C
Temperature unit	°C

Press **mode** to exit the user settings.

## INSTALLER SETTINGS

### ACCESS

You access to installer settings in 4 steps:  
From Auto, Comfort, Eco or Frost protection mode :

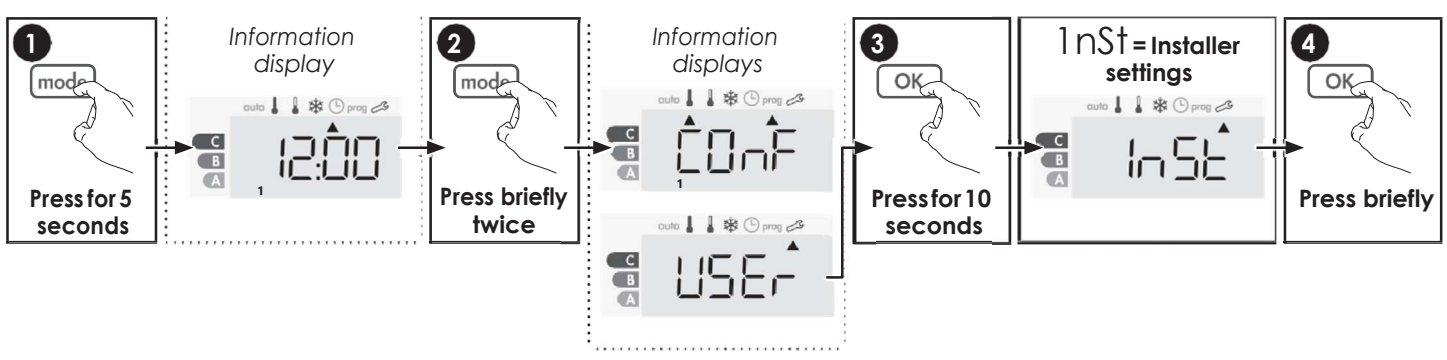

**Setting sequence:**

Open window detection > PiN code lock > Restoring factory settings

## OPEN WINDOW DETECTION, ACTIVATION/ DEACTIVATION OF THE AUTO MODE

The automatic mode enabled is the default setting.

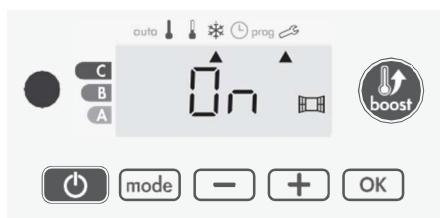

- 1- Press **-** or **+**.  
**On** = automatic mode enabled.  
**OFF** = automatic mode disabled.

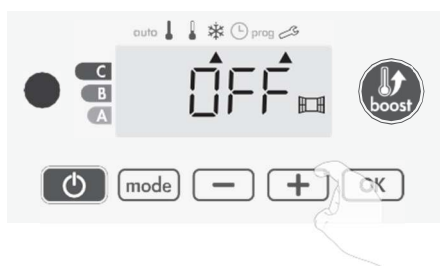

- 2- To save and move automatically to the next setting, press **OK**. To exit the user settings, press **mode** 3 times.

## PIN CODE LOCK

### ● Overview

Your heating device is protected by a safety code against nonauthorised use. The PIN code (Personal Identity Number) is a customisable 4 numbers code. When enabled, it prevents access to the following settings:

- Selecting the Comfort mode : The access to the Comfort mode is forbidden, only the Auto, Eco and Frost protection modes are available.
- Minimum and maximum Limits of the setting temperature range (the Comfort temperature modification is forbidden out of the authorised setting range).
- Programming mode.
- Open window detection settings.
- Setting the Eco mode temperature lowering-level.
- Setting the Frost protection temperature.

3 important steps are needed for the first use of the PIN code lock:

- 1 - **PIN code initialisation**, enter the preset PIN code (0000) to access to the feature.
- 2 - **Activation of the PIN Code** to lock settings which will be protected by the PIN code.
- 3 - **Customizing the PIN code**, replace 0000 by the customized code

### ● PIN code initialisation

By default, the PIN code is not enabled. **OFF** appears on the display.

- 1- By default registered PIN code is 0000.  
 Press **-** or **+** to select 0. It is blinking. Save by pressing **OK**.

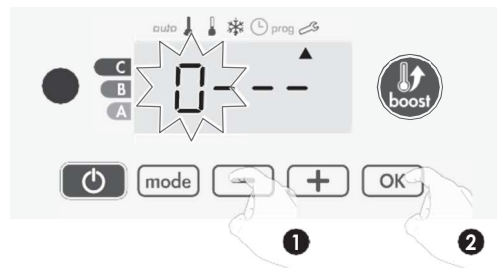

- 2- For others numbers, select 0 by press **OK**.  
 When 0000 appears, press on **OK** again to save and exit.

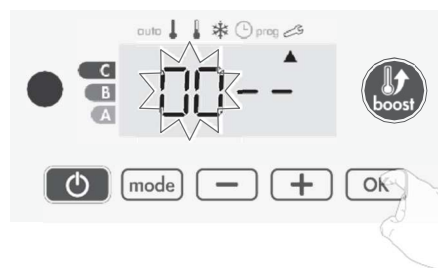

The PIN code is initialized, the next setting automatically appears: PIN Code activation.

### ● Activation/deactivation of the PIN Code

- 1- **OFF** appears on the display.  
 Press **-** or **+** to enable PIN code.  
**On** appears on the display.  
**On** = PIN code enabled  
**OFF** = PIN code disabled

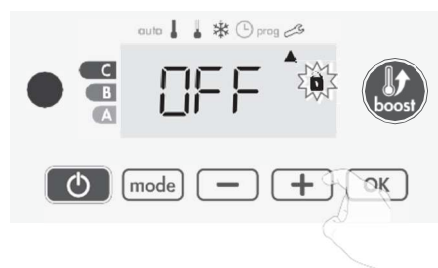

- 2- Press **OK** to save and return to the home installer settings display.

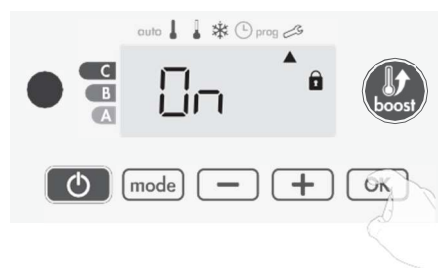

The PIN code is enabled. Any modification of reserved settings listed in "Overview" is now impossible.

● **Customizing the PIN code**

If you have just activated the PIN code, follow the stages described below.  
 Alternatively, you must copy the steps 1 and 2 of the initialisation process as well as the steps 1 and 2 of the activation process before personalising the PIN code.  
 Please remember that the personalisation of the PIN code can only be set once the initialisation and activation of the PIN code has been completed.

1- When **On** appears, press **OK** for at least 5 seconds.

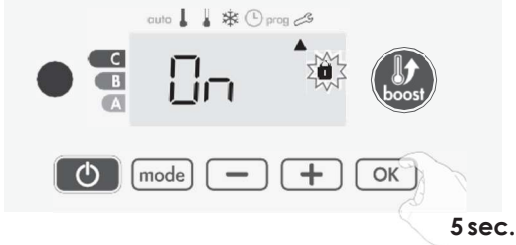

2- The 0000 code appears and the first number blinks. Press **-** or **+** to select the first desired number then press **OK** to save and exit. Repeat this operation for remaining 3 numbers.

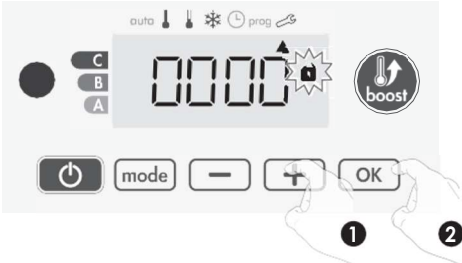

3- Press **OK** to confirm. The new code is now saved.



4- Press again on **OK** to exit setting PIN code mode and go back to the home display of the installer settings.



To exit the Installer settings, press **mode** twice.

**RESTORING FACTORY SETTINGS**

If the PIN code protection is disabled, the user and installer settings are re-initialized:

1- From the PIN code setting, press **OK**. **rESt** appears briefly on the display.



2- **nO** appears. Press **-** or **+** to select **yES**.

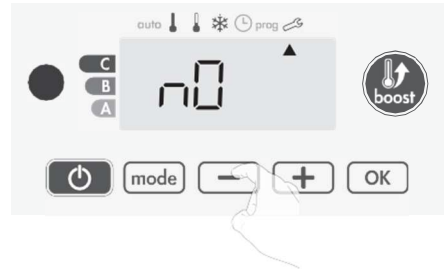

**yES** = Factory settings reset  
**nO** = Factory settings not reset

3- Press the key **OK** for 5 seconds. The device returns to its initial configuration and goes back automatically to the home display of the installer settings.

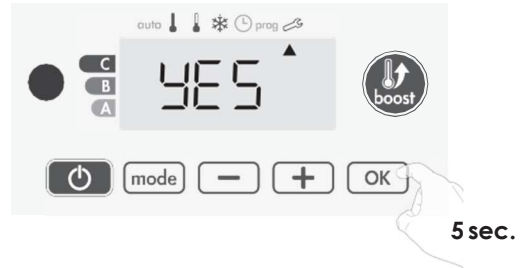

The following factory values will be effective:

Settings	Factory settings
<b>Operating</b>	
Comfort setting temperature	19°C
Boost duration	60 min.
Keypad lock	Disabled
<b>User settings</b>	
Backlighting	L3
Eco mode temperature lowering-level	-3,5°C
Frost protection temperature	7°C
Minimum set of Comfort setting temperature	7°C
Maximum set of Comfort setting temperature	30°C
Maximal Boost duration	60 min.
Maximum ambient temperature for the automatic stop of the Boost	39°C
Temperature unit	°C
<b>Installer settings</b>	
Automatic open window detection	Enabled
PIN code protection	Disabled
Value of the PIN code	0000

To exit the installer settings, press **mode** twice.



# EXPERT SETTINGS

## ACCESS

You access to expert settings in 5 steps.  
From Auto, Comfort, Eco or Frost protection mode :

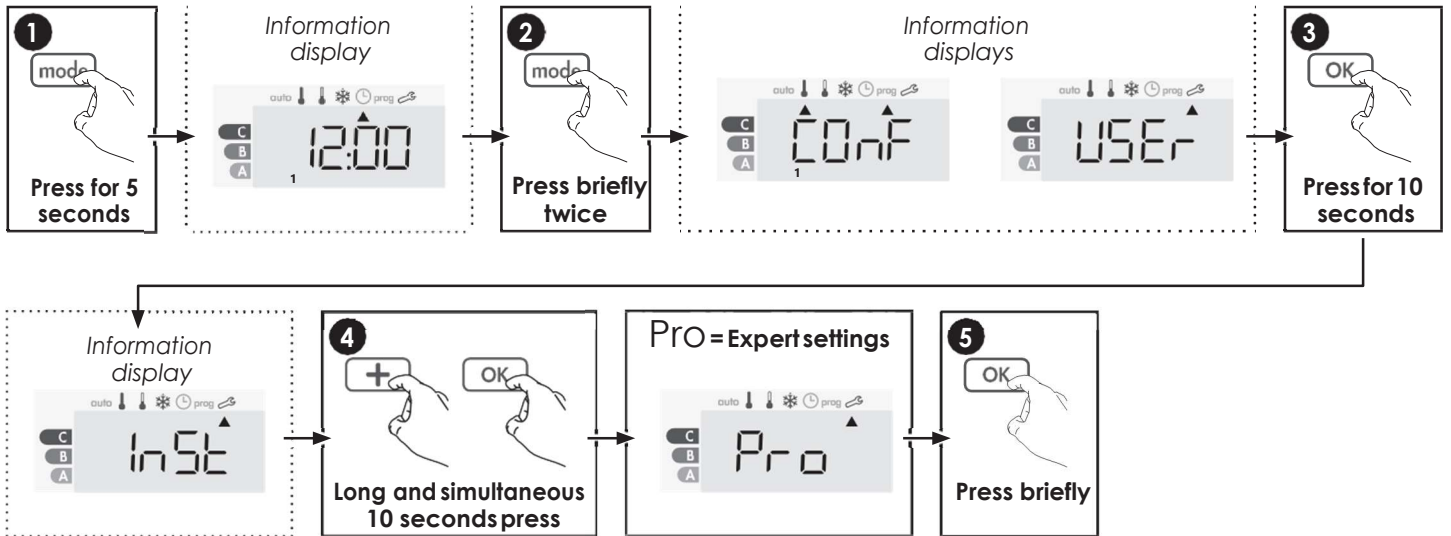

### Setting sequence:

Ambient temperature sensor adjustment > Setting the power > Restoring factory settings

## AMBIENT TEMPERATURE SENSOR ADJUSTEMENT

### ● Overview

**Important: This operation is reserved for professional installers only; any wrong changes would result in control anomalies.**

In which case if the temperature measured (measured by reliable thermometer) is different by at least 1°C or 2°C compared to the setting temperature of the radiator.

The calibration adjusts the temperature measured by the ambient temperature sensor to compensate for a deviation from +5°C to -5°C by intervals of 0.1°C.

### ● Ambient temperature sensor adjustment

#### 1- If the room temperature difference is negative, example :

Setting temperature (what you want) = 20°C.  
Ambient temperature (what you read on a reliable thermometer) = 18°C.  
Difference measured = -2°C.

**Important: Before carrying out the calibration it is recommended to wait for 4h after the setting temperature modification to insure that the ambient temperature is stabilized.**

To correct, then proceed as follows :

Sensor temperature = 24°C

**(The measured temperature may be different due to the location of the thermostat in the room).**



Decrease the temperature measured by the ambient temperature sensor by 2°C by pressing [-].

In our example the measured temperature by the sensor goes from 24°C to 22°C.



#### 2- If the room temperature difference is positive, example :

Setting temperature (what you want) = 19°C.  
Ambient temperature (what you read on a reliable thermometer) = 21°C.  
Difference measured = +2 °C.

To correct, then proceed as follows :

Sensor temperature = 21°C

**(The measured temperature may be different due to the location of the thermostat in the room).**



Increase the temperature measured by the ambient temperature sensor by 2°C by pressing **+**.  
 In our example the measured temperature by the sensor goes from 21°C to 23°C.



To validate, save the new value and exit the mode, press **OK**.  
 To exit the Expert settings, press **mode** 3 times.

● **The reset to zero of the sensor calibration**

To put the value of the correction to "0", do the following :

- 1- When the temperature measured by the sensor appears, press **-** or **+** for at least 3 seconds.



- 2- To save and move automatically to the next setting press **OK**. To exit the Expert settings, press **mode** 3 times.

**Important:** These changes should be performed by a qualified staff, it should be performed in production or on site during the first installation

**SETTING THE POWER**

To have a controller adapted to the towel rails and estimate the energy consumed, it is essential to set the power of the device.

- 1- Pre set value: 500W. Select a value between 500W and 1500W by pressing **-** or **+**.



- 2- To save and move automatically to the next setting press **OK**.



- 3- To save the Expert settings, press **mode** 3 times.

**RESTORING FACTORY SETTINGS**

If the PIN code protection is disabled, the user, installer and expert settings are re-initialized:

- 1- From the Power setting setting, press **OK**. **rESt** appears on the display.



- 2- **nO** appears. Press **-** or **+** to select **yES**.

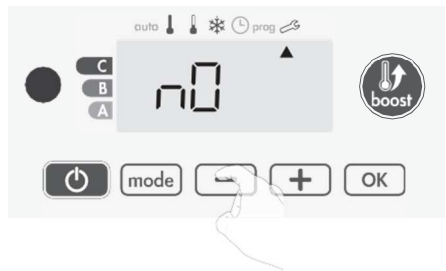

**yES** = Factory settings reset

**nO** = Factory settings not reset

- 3- Press the key **OK** for 5 seconds. The device returns to its initial configuration and goes back automatically to the Auto mode.



The following factory values will be effective:

Settings	Factory settings
<b>Operating</b>	
Comfort setting temperature	19°C
Boost duration	60 min.
Keypad lock	Disabled
<b>User settings</b>	
Backlighting	L3
Eco mode temperature lowering-level	-3,5°C
Frost protection temperature	7°C
Minimum set of Comfort setting temperature	7°C
Maximum set of Comfort setting temperature	30°C
Maximal Boost duration	60 min.

Settings	Factory settings
Maximum ambient temperature for the automatic stop of the Boost	39°C
Temperature unit	°C
Installer settings	
Automatic open window detection	Enabled
PIN code protection	Disabled
Value of the PIN code	0000
Experts settings	
Power	500W

To exit the Expert settings, press  3 times.

**MAINTENANCE TIPS**

Maintenance operations must be done with the heater switched off. Therefore make sure that the appliance is off. In order to ensure your heater lasts, we recommend you use the following few tips:

- Use only mild cleaning agents when cleaning and wiping of the radiator (no abrasive or corrosive product).
- Use a dry cloth (without solvent) for the control unit.
- Any modification to the essential safety elements (such as the characteristics and the power of the heating resistance, the type and volume of the special fluid filling the electrical radiator) is not permitted.
- Unprofessional actions of such a kind immediately cancels the warranty.

Waste disposal

The symbol on the product label indicates that the product may not be handled as domestic waste, but must be sorted separately. When it reaches the end of its useful life, it shall be returned to a collection facility for electrical and electronic products. By returning the product, you will help to prevent possible negative effects on the environment and health to which the product can contribute if it is disposed of as ordinary domestic waste. For information about recycling and collection facilities, you should contact your local authority/municipality or refuse collection service or the business from which you purchased the product. Applicable to countries where this Directive has been adopted.



**TECHNICAL DATA**

Nr of tubes	16	24			
Height (mm)	775	1181			
Length (mm)	585	400	450	495	585
Output (W)	400	400	500	600	700
Article nr	0184A0002	0184A0016	0184A0017	0184A0004	0184A0005

Nr of tubes	28				36	
Height (mm)	1411				1763	
Length (mm)	400	450	495	585	495	585
Output (W)	500	600	700	900	1000	1000
Article nr	0184A0018	0184A0019	0184A0010	0184A0011	0184A0007	0184A0008

Voltage: 230V~50Hz  
 Class II - IP44  
 Heating body in steel  
 Heating element with integrated thermal limiter and thermal fuse

Reference (s) of the model:	0184A0002, 0184A0004, 0184A0005, 0184A0007, 0184A0008, 0184A0010, 0184A0011, 0184A0016, 0184A0017, 0184A0018, 0184A0019						
Item	Symbol	Value	Unit	Item	Unit		
<b>Heat output</b>				<b>Type of heat output/room temperature control (select one)</b>			
Nominal heat output	<i>P<sub>nom</sub></i>	0.4/0.6/0.7/0.9/1.0	kW	single stage heat output, no room temperature control	No		
Minimum heat output (indicative)	<i>P<sub>min</sub></i>	0.4/0.6/0.7/0.9/1.0	kW	two or more manual stages, no room temperature control	No		
Maximum heat output	<i>P<sub>max,c</sub></i>	0.4/0.6/0.7/0.9/1.0	kW	with mechanic thermostat room temperature control	No		
<b>Auxiliary electricity consumption</b>				with electronic room temperature control	No		
At nominal heat output	<i>El<sub>max</sub></i>	0.4/0.6/0.7/0.9/1.0	kW	with electronic room temperature control plus day timer	No		
At minimum heat output	<i>El<sub>min</sub></i>	0.4/0.6/0.7/0.9/1.0	kW	with electronic room temperature control plus week timer	Yes		
In standby mode	<i>E<sub>ISB</sub></i>	<0.001	kW	<b>Other control options (multiple selections possible)</b>			
				room temperature control, with presence detection	No		
				room temperature control, with open window detection	Yes		
				with distance control option	No		
				with adaptive start control	No		
				with working time limitation	No		
				with black bulb sensor	No		
Contact details:		Stelrad Radiator Group Welvaartstraat 14 bus 6 B-2200 Herentals - Belgium					

Standards :

EMC	Low voltage	RoHS
EN55014-1	EN60335-1	EN50581
EN55014-2	EN60335-2-30	
EN61000-3-2	EN60335-2-43	
EN61000-3-3	EN62233	